



Australian Government

Australian Transport Safety Bureau



ATSB TRANSPORT SAFETY REPORT
Aviation Research and Analysis Report – AR-2008-018(1)
Final

Runway excursions

Part 1: A worldwide review of commercial jet aircraft runway excursions



Australian Government

Australian Transport Safety Bureau

ATSB TRANSPORT SAFETY REPORT

Aviation Research and Analysis Report
AR-2008-018(1)

Final

Runway excursions

Part 1

**A worldwide review of commercial jet aircraft runway
excursions**

Published by: Australian Transport Safety Bureau
Postal address: PO Box 967, Civic Square ACT 2608
Office location: 62 Northbourne Ave, Canberra City, Australian Capital Territory
Telephone: 1800 020 616; from overseas + 61 2 6257 4150
Accident and incident notification: 1800 011 034 (24 hours)
Facsimile: 02 6247 3117; from overseas + 61 2 6247 3117
E-mail: atsbinfo@atsb.gov.au
Internet: www.atsb.gov.au

© Commonwealth of Australia 2009.

This work is copyright. In the interests of enhancing the value of the information contained in this publication you may copy, download, display, print, reproduce and distribute this material in unaltered form (retaining this notice). However, copyright in the material obtained from other agencies, private individuals or organisations, belongs to those agencies, individuals or organisations. Where you want to use their material you will need to contact them directly.

Subject to the provisions of the *Copyright Act 1968*, you must not make any other use of the material in this publication unless you have the permission of the Australian Transport Safety Bureau.

Please direct requests for further information or authorisation to:

Commonwealth Copyright Administration, Copyright Law Branch
Attorney-General's Department, Robert Garran Offices, National Circuit, Barton ACT 2600
www.ag.gov.au/cca

ISBN and formal report title: see 'Document retrieval information' on page v.

CONTENTS

THE AUSTRALIAN TRANSPORT SAFETY BUREAU	vi
EXECUTIVE SUMMARY	vii
ABBREVIATIONS.....	ix
1 INTRODUCTION	1
1.1 Background.....	1
1.2 What are runway excursions?.....	2
1.3 Objectives	3
1.4 Scope	3
2 METHODOLOGY	5
2.1 Data sources.....	5
2.2 Data analysis of runway excursions	6
3 SUMMARY OF RUNWAY EXCURSION ACCIDENTS	7
3.1 General commercial aircraft accident trends	7
3.2 General runway excursion trends	8
3.3 Major international runway excursions	11
3.4 Australian runway excursions	14
3.5 Flight Safety Foundation review of approach and landing accidents	19
3.6 Worldwide runway excursion accident analysis summary	21
4 CREW TECHNIQUE AND DECISION-RELATED FACTORS IN RUNWAY EXCURSION ACCIDENTS.....	25
4.1 Unstabilised approaches	26
4.1.1 Unstable approaches and runway excursions	28
4.1.2 Causes and recovery from unstabilised approaches.....	29
4.2 Too fast, too long.....	30
4.3 Delayed braking and flight crew action.....	32
4.3.1 Causes of reduced or inappropriate deceleration	35
4.4 ‘Press-on-itis’ and flight crew management	37
4.5 Go-arounds	38
5 CREW PERFORMANCE-RELATED FACTORS IN RUNWAY EXCURSION ACCIDENTS	43
5.1 Awareness/compliance with SOPs and MELs	44
5.2 Inadequate SOPs.....	45

5.3	Stress, fatigue and task saturation.....	46
5.4	Visual illusions and other human factor considerations	48
5.4.1	Airport environment illusions	49
5.4.2	Runway illusions	50
5.4.3	Weather illusions	51
6	WEATHER-RELATED FACTORS IN RUNWAY EXCURSION ACCIDENTS.....	57
6.1	Water-affected and contaminated runways	60
6.2	Tailwinds and crosswinds.....	61
6.2.1	Tailwinds	61
6.2.2	Crosswinds.....	62
6.3	How much do weather and runway conditions really affect the landing rollout length?.....	64
6.3.1	Regulatory standards on runway rollout length.....	68
6.3.2	Runway condition reporting standards	68
7	SYSTEMS-RELATED FACTORS IN RUNWAY EXCURSION ACCIDENTS.....	73
7.1	Aquaplaning	74
7.2	Runway design	75
8	CONCLUSION	77
9	REFERENCES.....	79
10	APPENDICES.....	83
10.1	Appendix A – Sources and submissions.....	83
10.1.1	Sources of information.....	83
10.1.2	Submissions	83
10.2	Appendix B - Worldwide runway excursion accidents, 1998 to 2007, as identified from the Ascend World Aircraft Accident Summary.....	84
10.2.1	Landing accidents	84
10.2.2	Takeoff accidents.....	89
10.3	Appendix C - Flight Safety Foundation contributing factors classification for runway excursion accidents	91
10.4	Appendix D - FAA/industry-agreed braking action definitions	95
10.5	Appendix E - FAA sample worksheet for calculating landing length	96
10.6	Appendix F - Tailwind limits for common commercial aircraft	97
10.7	Appendix G - Landing force calculations.....	98

DOCUMENT RETRIEVAL INFORMATION

Report No.	Publication date	No. of pages	ISBN
AR-2008-018(1)	April 2009	114	978-1-921602-25-2

Publication title

Runway excursions: Part 1 – A worldwide review of commercial jet aircraft runway excursions

Author(s)

Taylor, R. P.
Hughes, K.
Godley, S.

Prepared by

Australian Transport Safety Bureau
PO Box 967, Civic Square ACT 2608 Australia
www.atsb.gov.au

Reference No.

Mar2009/INFRA-08435

Acknowledgements

Photos courtesy of Chicago Tribune, USA Today, and Associated Press.

Abstract

Over the last decade there has been a noticeable reduction in the number of non-fatal and fatal accidents involving the worldwide commercial jet aircraft fleet. Despite this, runway excursions continue to remain prevalent, accounting for approximately a quarter of all incidents and accidents in air transport, and 96 per cent of all runway accidents. Runway excursions involve aircraft running off the end of the runway (overrun) or departing the side of the runway (veer-off).

A number of catastrophic runway excursions occurred across the world in 2007 and 2008, resulting in hundreds of fatalities and significant property damage in communities adjacent to the airport. This report, the first in a two-part series, provides a statistical picture of runway excursion accidents over a 10-year period – how frequently they occur, why they occur, and what factors contributed to those accidents.

A search of the Ascend World Aircraft Accident Summary identified 141 runway excursion accidents involving the worldwide commercial jet aircraft fleet between 1998 and 2007. Those accidents resulted in 550 fatalities. Of those 141 accidents, 120 occurred during the landing phase of flight. An in-depth analysis of those 120 accidents was conducted in order to identify the types of flight crew technique and decision-related, flight crew performance-related, weather-related, and systems-related factors that contribute to runway excursions.

Fortunately, Australia has not experienced a runway excursion accident of the severity of those seen overseas. However, given the proximity of Australia's major airports to urban residential and industrial areas, Australia is not immune. Since 1998, three excursions of Australian-registered commercial jet aircraft have been investigated by the Australian Transport Safety Bureau. While two of those incidents were relatively minor, one incident involving a runway overrun in Thailand resulted in substantial damage to the aircraft.

THE AUSTRALIAN TRANSPORT SAFETY BUREAU

The Australian Transport Safety Bureau (ATSB) is an operationally independent multi-modal bureau within the Australian Government Department of Infrastructure, Transport, Regional Development and Local Government. ATSB investigations are independent of regulatory, operator or other external organisations.

The ATSB is responsible for investigating accidents and other transport safety matters involving civil aviation, marine and rail operations in Australia that fall within Commonwealth jurisdiction, as well as participating in overseas investigations involving Australian registered aircraft and ships. A primary concern is the safety of commercial transport, with particular regard to fare-paying passenger operations.

The ATSB performs its functions in accordance with the provisions of the *Transport Safety Investigation Act 2003* and Regulations and, where applicable, relevant international agreements.

Purpose of safety investigations

The object of a safety investigation is to enhance safety. To reduce safety-related risk, ATSB investigations determine and communicate the safety factors related to the transport safety matter being investigated.

It is not the object of an investigation to determine blame or liability. However, an investigation report must include factual material of sufficient weight to support the analysis and findings. At all times the ATSB endeavours to balance the use of material that could imply adverse comment with the need to properly explain what happened, and why, in a fair and unbiased manner.

Developing safety action

Central to the ATSBs investigation of transport safety matters is the early identification of safety issues in the transport environment. The ATSB prefers to encourage the relevant organisation(s) to proactively initiate safety action rather than release formal recommendations. However, depending on the level of risk associated with a safety issue and the extent of corrective action undertaken by the relevant organisation, a recommendation may be issued either during or at the end of an investigation.

The ATSB has decided that when safety recommendations are issued, they will focus on clearly describing the safety issue of concern, rather than providing instructions or opinions on the method of corrective action. As with equivalent overseas organisations, the ATSB has no power to implement its recommendations. It is a matter for the body to which an ATSB recommendation is directed (for example the relevant regulator in consultation with industry) to assess the costs and benefits of any particular means of addressing a safety issue.

About ATSB investigation reports: How investigation reports are organised and definitions of terms used in ATSB reports, such as safety factor, contributing safety factor and safety issue, are provided on the ATSB web site www.atsb.gov.au.

EXECUTIVE SUMMARY

Despite a continuing downwards trend in commercial aircraft hull loss rates over the last decade, approach and landing accidents are one area that has shown little improvement in safety.

In particular, over the last few years several catastrophic landing accidents have occurred involving aircraft running off the end of the runway (overrun) or departing the side of the runway (veer-off). Overruns and veer-offs - collectively termed as runway excursions - have gained significant media attention and brought this issue very much into the public eye due to the catastrophic consequences to life and property often associated with such accidents. In particular, 2007 saw a number of notable runway excursion accidents in Thailand, Indonesia and Brazil that claimed a total of 309 lives. More recently, runway excursion accidents were brought to the attention of the public with the May 2008 overrun of an Airbus A320 in Honduras that resulted in five fatalities, and a Learjet 60 overrun in South Carolina in September 2008, which resulted in four fatalities.

The purpose of this study was to provide an overview of runway excursion accidents from both an international and Australian perspective. The study has been divided into two parts:

- Part 1 (this report) examines worldwide trends in runway excursion accidents involving commercial jet aircraft over a 10-year period (1998 to 2007), and explores the prevalence of safety factors that contribute to these types of accidents.
- Part 2 of the study will discuss the impact of a major runway excursion accident from an Australian perspective, and identify the safeguards that exist at Australian airports to safely control a runway excursion if one occurs. It will also explore a range of physical and procedural safeguards that can assist airlines and airport operators to reduce the risk of a runway excursion occurring, and control the impact to life and property if one does occur.

For Part 1 of the study, a search was conducted of the Ascend World Aircraft Accident Summary to identify accidents that were classified as runway excursions (either overruns or veer-offs). The study focused on the worldwide commercial jet aircraft fleet for the calendar year period 1998 to 2007, and found that:

- there were 141 runway excursion accidents identified over the 10-year reporting period, that resulted in 550 fatalities to passengers, crew and persons on the ground;
- of those 141 accidents, 120 occurred during the landing phase of flight; and
- the most common types of contributing factors to runway excursions on landing were flight crew technique or decision-related factors, and weather-related factors. These accounted for 71 per cent of 343 factors identified that contributed to those 120 accidents.

Runway excursions are often the product of a series of events. Accident investigation reports and the Ascend accident summaries for the 120 excursions during landing were analysed to identify the types of factors that contributed to those accidents. The factors were then categorised based on the Flight Safety Foundation contributing factors classification for runway excursion accidents. A

number of flight crew technique and decision-related, flight crew performance-related, weather-related and systems-related factors were found to be common contributors to these types of accidents, including the following:

- Flight crew technique and decision-related factors
 - flying an unstabilised approach
 - landing too fast, too far down the runway, or conducting an extended flare
 - delayed or incorrect braking action
 - ‘press-on-itis’
 - not conducting a missed approach or go-around despite unsafe landing conditions
- Flight crew performance-related factors
 - less than adequate flight crew awareness of procedures or systems
 - spatial disorientation, visual illusions, fatigue and task saturation
 - less than adequate operator procedures for assessing whether weather or runway conditions are safe for landing
 - less than adequate awareness of the effect of weather and runway conditions on actual landing rollout length
- Weather-related factors
 - operating on a wet or contaminated runway
 - landing in heavy rain, wind shear, excessive tailwinds or crosswinds
 - inconsistent reporting of runway conditions and braking action at airports across the world
- Systems-related factors
 - aquaplaning on a wet runway
 - malfunction or unexpected action of braking systems.

In most runway excursions, any one or combination of these factors can lead to an unsafe outcome because of non-adherence to standard operating procedures, or less than adequate operator procedures for safe approaches and landings. In the majority of the accidents studied, less than adequate procedures or non-adherence to procedures led to:

- an unstabilised approach, resulting in a long, fast, or otherwise unsafe landing;
or
- a landing in poor weather conditions with unsuitable runway conditions for the aircraft type, resulting in a loss of control on the runway.

At the time of writing, Australia has been fortunate not to have experienced a serious runway excursion accident as seen overseas. However, it is important to recognise that the risk of a runway excursion accident is ever present and that a range of safety measures should be utilised by aircraft operators and airport owners and managers to ensure the risk remains at an acceptable level.

ABBREVIATIONS

a	Acceleration
AC	Advisory circular
AFM	Aircraft flight manual
AIP	Aeronautical Information Publication
ALA	Approach and landing accident
ALAR	Approach and landing accident reduction
ATC	Air traffic control
ATSB	Australian Transport Safety Bureau
C	Centre, centigrade
C_L	Lift coefficient
C_{Lmax}	Maximum lift coefficient
CAA	Civil Aviation Authority (United Kingdom)
CASA	Civil Aviation Safety Authority
CASR	Civil Aviation Safety Regulation
CAST	Commercial Aviation Safety Team
CFIT	Controlled flight into terrain
CIS	Commonwealth of Independent States
CRM	Crew resource management
CVR	Cockpit voice recorder
DDG	Dispatch Deviation Guide
DGAC	Direction de l'Aviation Civile (France)
EGPWS	Enhanced ground proximity warning system
F	Force
FAA	Federal Aviation Administration (United States)
FAR	Federal Aviation Regulation (FAA)
FDR	Flight data recorder
FSF	Flight Safety Foundation
ft	Feet
GPWS	Ground proximity warning system
IATA	International Air Transport Association
ICAO	International Civil Aviation Organization

IFALPA	International Federation of Air Line Pilots' Associations
ILS	Instrument landing system
IMC	Instrument meteorological conditions
ISA	International Standard Atmosphere
JAA	Joint Aviation Authorities (Europe)
JAR	Joint Aviation Regulation (JAA)
JSAT	Joint Safety Analysis Team
JSSI	European Joint Aviation Authorities Safety Strategy Initiative
kg	Kilogram
kts	Knots
kN	Kilonewton (force)
kPa	Kilopascals (pressure)
L	Left, lift
lb	Pound
(L/D)_{app}	Lift-drag ratio (approach)
LOSA	Line operations safety audit
m	Metre
m/s	Metres per second
mm	Millimetres
min	Minute
MEL	Minimum equipment list
μ (Mu)	Friction coefficient
n	Number of occurrences
N	Reaction force at the main gear
NLR	National Aerospace Laboratory, The Netherlands (Nationaal Lucht- en Rulmtevaartlaboratorium)
NM	Nautical miles
NTSB	National Transportation Safety Board (United States)
OAT	Outside air temperature
PAPI	Precision approach path indicator
psi	Pounds per square inch (of pressure)

R	Right
ρ (rho)	Air pressure
RNAV(GNSS)	Area navigation global navigation satellite system
RPT	Regular public transport
s_L	Landing rollout length
SOP	Standard operating procedure
T_{rev}	Reverse thrust force
TAWS	Terrain awareness and warning system
TCH	Threshold crossing height
TSB	Transportation Safety Board of Canada
V_L	Aircraft touchdown speed (actual)
V_p	Critical dynamic aquaplaning speed
V_{ref}	Aircraft approach and landing speed (reference)
V_s	Aircraft stall speed
VMC	Visual meteorological conditions
VOR	Very high frequency omni-directional radio range
W_L	Aircraft landing weight
WAAS	World Aircraft Accident Summary (Ascend)

1 INTRODUCTION

1.1 Background

Worldwide commercial aircraft hull loss rates¹ have been steadily decreasing since 1996. Advances in technology and flight crew² training, better regulatory oversight, and a core focus by operators and regulators on reinforcing good safety practices throughout organisational, operational and support aspects of flight operations, have been driving this decrease (ISSG, 2006). Despite an overall increase in safety, approach and landing accidents (ALAs) continue to dominate as the primary cause of commercial jet hull losses. A Boeing analysis of worldwide commercial jet aircraft accidents since 1959 has shown that over half (52 per cent) of total accidents, and 33 per cent of fatal accidents, occur during the final approach and landing phase of flight. This is despite the fact that the approach and landing phase of flight accounts for only four per cent of the average flight time. Furthermore, the landing phase of flight alone accounts for 24 per cent of these fatal accidents (Boeing, 2006; Boeing, 2008).

Runway excursion accidents, which include aircraft running off the end of the runway (overruns) and off the side of the runway (veer-offs), account for a significant proportion of all ALAs. The International Federation of Airline Pilots Association (IFALPA) reports that almost one quarter (24 per cent) of all incidents and accidents in air transport operations are runway excursions (IFALPA, 2008). The Flight Safety Foundation (FSF) reports that runway excursions are significantly more of a safety concern than other ALAs such as runway incursions – accounting for 96 per cent of all runway accidents, 80 per cent of fatal runway accidents and 75 per cent of related fatalities. In comparison, runway incursions account for less than one accident per year on average (Werfelman, 2008).

Runway excursions are not rare events

'Runway excursions are not rare events,' said James M. Burin, FSF Director of Technical Programs.

'Many don't involve much damage and there are no injuries, some are serious and involve substantial damage, and a few are deadly.'

In most instances, a runway excursion is not a total surprise to the flight crew. We have proven several times each year that, if you're landing long and fast, with a tailwind, or on a contaminated runway, the consequences are predictable'.

Source: Werfelman, 2008

¹ Hull loss rate is a commonly used measure in the aviation insurance industry to determine whether an aircraft has been destroyed or written-off. A 'hull loss' is defined by Boeing as an aircraft that is 'totally destroyed or damaged beyond economic repair. Hull loss also includes, but is not limited to, events in which the aircraft is missing, the search for the wreckage has been terminated without it being located, or the aircraft is completely inaccessible' (Boeing, 2008).

² In this report, the term 'flight crew' refers to both single and multi-pilot operations.

Long-term Federal Aviation Administration (FAA) and National Transportation Safety Board (NTSB) studies estimate that approximately ten runway accidents occur worldwide each year involving turbine-powered commercial aircraft (FAA, 2007). Unfortunately, runway accident data over the last 10 years suggests that runway excursions are on the increase. Runway excursion accident data from the Ascend World Aircraft Accident Summary (WAAS) over the period 1998 to 2007, shows an average of 14.1 runway excursion accidents per year involving commercial jet aircraft – 12 excursion accidents per year during the landing phase of flight, and 2.1 per year in the take-off phase of flight.

Furthermore, several high-profile accidents in 2007 and 2008 have brought the issue of runway excursions to the forefront of aviation safety. Many of those accidents have sadly resulted in a large number of fatalities. In total, the Ascend WAAS recorded 550 fatalities across the 141 runway excursion accidents involving the worldwide commercial jet fleet from 1998 to 2007 (Ascend, 2007). The Boeing Statistical Summary of Commercial Jet Airplane Accidents puts this figure at a similarly high 538 fatalities over the same period. Of these 538 fatalities, 449 involved persons on board the aircraft, while the remaining 89 fatalities were persons outside the aircraft (Boeing, 2008).

1.2 What are runway excursions?

There are two types of runway excursion accidents: runway overruns, in which the aircraft goes off the runway end; and runway veer-offs, in which the aircraft goes off the side of the runway.

The definition of runway excursion, overrun and veer-off, vary somewhat between different regulators and aviation safety organisations, and are even used interchangeably.

The Australian Transport Safety Bureau (ATSB) defines a runway excursion as an occurrence (accident or incident) where an aircraft on the ground departs from a runway or taxiway. Excursions may occur on takeoff, taxiing or landing, and be either intentional or unintentional. The ATSB definition for a runway excursion does not differentiate between overruns and veer-offs.

To allow overruns and veer-offs to be compared, the definitions set by the Flight Safety Foundation were adopted in this report.

Types of runway excursions

Runway **overruns** occur when the aircraft rollout extends beyond the end of the runway.

Runway **veer-offs** occur when:

- aircraft veer off the side of the runway during the landing roll; or
- aircraft veer off the side of the runway or taxiway when exiting the runway.

Source: Werfelman, 2008

1.3 Objectives

The purpose of this study was to provide an international and Australian perspective on runway excursion accidents involving commercial jet aircraft.

This study is divided into two parts, published as two separate reports:

- Part 1 (this report) explores the contributing factors associated with runway excursions of commercial jet aircraft through the analysis of accidents between 1998 and 2007.
- Part 2 of this study will discuss the impact of runway excursion accidents on communities located near airports, and the preventative risk controls that have been or could be put in place to minimise this risk, or mitigate its effects if an excursion did occur.

Specifically, the objectives of the current report (Part 1) were to:

- identify worldwide runway excursion trends for commercial jet aircraft in the last 10 years (1998 to 2007);
- identify runway excursion occurrences involving commercial jet aircraft in Australia, or occurrences overseas involving Australian VH-registered aircraft; and
- identify and explore the factors that contribute to runway excursion accidents, based on an analysis of official investigation reports, and accident summaries from the Ascend WAAS.

1.4 Scope

This report focused on runway excursion accidents (both runway overruns and runway veer-offs) for larger commercial jet aircraft, focusing on excursions during the landing phase of flight.

Worldwide, runway excursion accidents have resulted in a large number of fatalities over the years. This has been particularly evident by the recent spate of accidents that have occurred internationally involving commercial jet aircraft. These include:

- an overrun of a Airbus A320 at Tegucigalpa, Honduras on 30 May 2008 that resulted in 5 fatalities;

- an overrun of a McDonnell Douglas MD-82 at Phuket, Thailand on 16 September 2007 that resulted in 90 fatalities;
- an overrun of a Airbus A320 at Sao Paulo, Brazil on 17 July 2007 that resulted in 199 fatalities; and
- an overrun of a Boeing 737-400 at Yogyakarta, Indonesia on 7 March 2007 that resulted in 22 fatalities.

Due to the sizable number of potential fatalities associated with runway excursions involving commercial airlines, this report focused on accidents involving commercial jet aircraft only.

Furthermore, previous research has indicated that 33 per cent of fatal accidents and 22 per cent of fatalities involving the worldwide commercial jet aircraft fleet, occur during the final approach and landing phases of flight. Of those, 24 per cent of the fatal accidents occurred during landing, accounting for 11 per cent of the fatalities (Boeing, 2008). Runway excursions during the take-off phase normally happen after high-speed rejected takeoffs, and the majority occurring at lower speeds than those during the landing phase, and hence present a lower risk of injury to occupants and damage to the aircraft or surrounding infrastructure (van Es, 2005). Consequently, this report predominately focused on runway excursion accidents that occurred during the landing phase of flight, rather than at takeoff.

This report excluded runway excursion accidents involving:

- smaller jet aircraft (International Civil Aviation Organization Aeroplane Design Group Code A and B or FAA Code I and II)³;
- reciprocating and turboprop-powered aircraft⁴;
- private and military aircraft;
- Eastern-built or Commonwealth of Independent States-built aircraft⁵; and
- taxiway excursions, which occur at low speed and are unlikely to cause serious injury or significant aircraft damage.

³ These aircraft have a wingspan of less than 24 m, and have been excluded as the vast majority of commercial jet aircraft have a wingspan of greater than 24 m.

⁴ A September 2005 review by the Nationaal Lucht- en Ruimtevaartlaboratorium (Dutch National Aerospace Laboratory) of 400 runway excursion accidents that occurred worldwide between 1970 and 2004, determined that the difference in the landing runway excursion accident rate between jet-powered and turboprop-powered aircraft was not statistically significant at a five per cent confidence level (van Es, 2005).

⁵ Operational and accident data was limited for these aircraft types (Boeing, 2008).

2 METHODOLOGY

2.1 Data sources

Runway excursion data, 1998 to 2007

The runway excursion accidents⁶ analysed in this report involved commercial jet aircraft that were sourced from the Ascend⁷ World Aircraft Accident Summary (WAAS) Issue 147 for the period 1 January 1998 to 31 December 2007. Researched and published on behalf of the United Kingdom Civil Aviation Authority (CAA), this data represents all known runway excursion accidents for commercial jet aircraft over this period.

Analysis of the Ascend data identified 141 runway excursion accidents over this period. Of those accidents, 120 were associated with the landing phase of flight and so form the primary focus for this report. The remaining 21 accidents occurred when the aircraft was in the take-off phase of flight. A full list of the 141 accidents appears in Appendix B.

Further details regarding each accident identified in the Ascend data were obtained from the following sources:

- the Australian Transport Safety Bureau (ATSB) aviation accident and incident database and safety investigation reports;
- accident investigation reports published by the United States National Transportation Safety Board (NTSB), the Transportation Safety Board of Canada (TSB), the National Transportation Safety Committee of Indonesia (NTSC), and other international aviation safety investigation bodies; and
- Ascend WAAS.

Hull loss and fatality rate data

Commercial aircraft hull loss data and fatality rates for all accident types between 1998 and 2007 were sourced from the International Air Transport Association (IATA), and from the Boeing Statistical Summary of Commercial Jet Airplane Accidents, Worldwide Operations, 1959–2007.

Aircraft force data

As part of the evaluation into the amount of force required to stop a typical medium-sized commercial jet aircraft in different runway conditions, calculations of the estimated performance for the Boeing 787-8 Dreamliner were made. Baseline data for the Boeing 787 was based on a late-2005 baseline. This was sourced from the online edition of Jane's All the World's Aircraft and from the Piano aircraft

⁶ Accidents are defined by the International Civil Aviation Organization Annex 13 as occurrences where: a person is fatally or seriously injured; the aircraft sustains damage or structural failure (which affects structural strength, performance or flight characteristics, or requires major repair or replacement); or the aircraft is missing or inaccessible.

⁷ Ascend is a division of Airclaims.

database, which provided a performance model for this aircraft based on manufacturer data.⁸

It is important to note that the calculations provided in this report do not reflect the actual in-service performance of the Boeing 787 as this evaluation was based on a pre-production performance baseline and is not approved by Boeing. This baseline is unlikely to be the same as the actual performance of the Boeing 787 when it enters into service.

2.2 Data analysis of runway excursions

A systematic analysis of the Ascend WAAS text summaries provided for each of the 120 runway excursion landing accidents between 1998 and 2007 was conducted in order to identify common themes. Each accident was analysed to determine probable contributing factors. As a result, 343 contributing factors were identified.

Each factor was grouped into one of the four elements of the Flight Safety Foundation (FSF) approach and landing accident taxonomy (see Appendix C for details), (Khatwa & Helmreich, 1999) of:

- flight crew technique and decision-related factors;
- performance-related factors; and
- weather-related factors;
- systems-related factors.

Within each of these four categories, the contributing factors were further grouped into subtypes. These subtypes were validated against the contributing factors to runway excursion accidents that were identified in the FSF Approach-and-landing Accident Reduction (ALAR) Tool Kit Briefing Notes.⁹ In cases where more than one factor was assessed to have contributed to the excursion, all factors were coded into their most applicable subtypes for analysis.

The primary source of data used to determine the contributing factors for each runway excursion were the accident descriptions accompanying each accident record in the Ascend WAAS database. It is important to note that those accident descriptions were based on both official and unofficial sources, such as press reports or initial information at the accident scene.

Where available, official accident investigation reports were used to supplement this information, and to provide a more complete picture of the accident. Investigation reports were able to be sourced for 27 per cent of the runway excursions that were analysed (n = 32).

⁸ Piano is a globally trusted aeronautical analysis tool used by over twenty major international aerospace organisations to evaluate the operational performance of aircraft designs.

⁹ The FSF ALAR Briefing Notes were produced to help prevent ALAs, including runway excursions. The briefing notes were based on the data-driven conclusions and recommendations of the FSF ALAR Task Force, as well as data from the U.S. Commercial Aviation Safety Team (CAST), Joint Safety Analysis Team (JSAT), and the European Joint Aviation Authorities Safety Strategy Initiative (JSSI).

3

SUMMARY OF RUNWAY EXCURSION ACCIDENTS

3.1 General commercial aircraft accident trends

Air travel today is undoubtedly safer than it has been at any time in the past five decades. Between 1959 and 2007, 36 per cent of hull loss accidents involving the worldwide commercial jet aircraft fleet were fatal, while the remaining 64 per cent were non-fatal. In the last decade (1998 to 2007), the proportional change of fatal to non-fatal hull loss accidents has been encouraging, with only 25 per cent of hull loss accidents resulting in fatalities (Boeing, 2008).

Approach and landing accidents (ALAs), however, continue to remain prevalent, accounting for 33 per cent of fatal commercial jet aircraft accidents between 1998 and 2008, even though the approach and landing phase accounts for only four per cent of average flight time. The landing phase alone accounted for 24 per cent of these fatal accidents, despite the fact that the landing phase accounts for just one per cent of average flight time (Boeing, 2008).

Improvements in safety over the years can be partially attributed to advancements in technology. Aircraft are being fitted with an array of integrated safety systems such as the terrain awareness and warning system (TAWS); flight crews have access to enhanced navigational and guidance systems, such as the instrument landing system (ILS) and area navigation global navigation satellite system (RNAV (GNSS)); and air traffic controllers operate within a more sophisticated air traffic management system. These systems, in conjunction with standard operating procedures and crew resource management skills, assist approaches and landings in challenging terrain and weather conditions.

In the last decade, aviation safety regulators have taken a more proactive approach to ensure airports provide adequate graded safety areas around runways to minimise damage to life and property in the event of an accident. In the United States, for example, the Federal Aviation Administration (FAA) has been working since 2000 to improve runway safety areas at commercial airports to meet design standards, and to work with airport operators to find alternative solutions where it has not been possible to provide full runway safety areas due to terrain or urban limitations. As a result, over 72 per cent of commercial runways in the United States now substantially meet the FAA runway safety area standards (up from 46 per cent in 1990), and only three per cent of runways will not be improved to meet the standards (down from 36 per cent in 1996) (ICAO, 2007).

Despite the range of safety improvements, ALAs are an area that has shown little or no safety improvement for over a decade worldwide (McKinney, 2006). According to Boeing data, ALA accidents contribute to 54 per cent of all commercial jet hull losses (Boeing, 2006).

Runway excursions are the third most frequent fatal accident type for worldwide commercial jet aircraft and the second most frequent type of fatal ALA, with controlled flight into terrain (CFIT) accounting for the greatest proportion of ALAs (see Figure 1). In terms of the total number of fatalities recorded between 1998 and 2007 for commercial jet aircraft, runway excursion accidents rated fourth highest

behind in-flight loss of control, CFIT, and system/component failure or malfunction accidents.

Figure 1: Number of fatal accidents for the worldwide commercial jet fleet, 1998 to 2007, by occurrence category as assigned by the Commercial Aviation Safety Team (CAST)

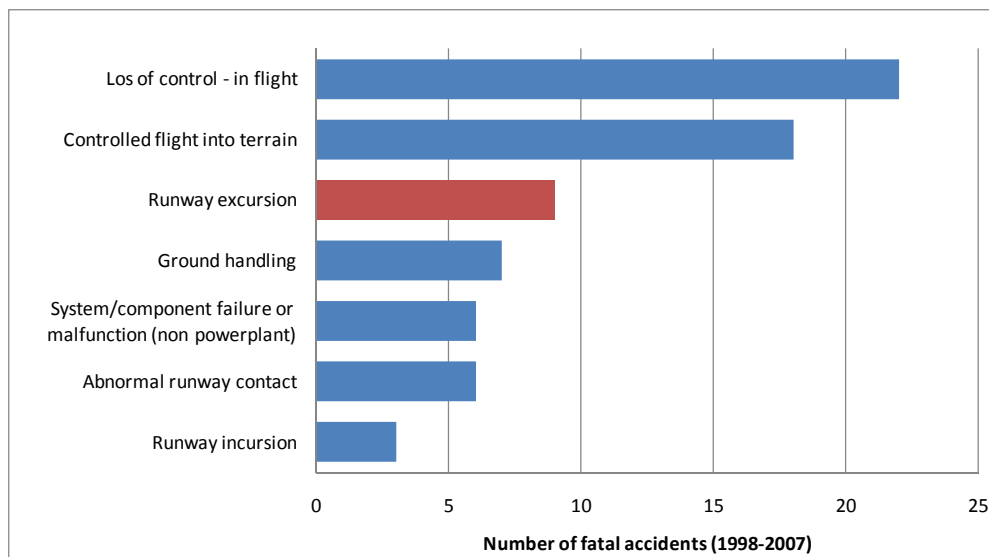

Source: Boeing, 2008

Runway excursion accidents were responsible for 449 onboard fatalities and 89 fatalities on the ground (Boeing, 2008). The Flight Safety Foundation (FSF) Approach and Landing Accident Reduction (ALAR) Task Force conducted a study of 287 fatal approach and landing accidents between 1980 and 1996 involving turbine-powered commercial aircraft. This study found that approximately 20 per cent of all ALAs were runway excursions. Of this 20 per cent, runway overruns accounted for 14.1 per cent (Khatwa & Helmreich, 1999).

The FSF reported that 96 per cent of all runway accidents are excursions, and that these comprise 80 per cent of all fatal runway accidents and 75 per cent of related fatalities (Werfelman, 2008). In the first 7 months of 2006 alone, the cumulative death toll resulting from runway overruns was over 200 (IFALPA, 2008). Three catastrophic overruns occurred in 2007 (all with multiple fatalities), and at least two overruns involving commercial jet aircraft have occurred in 2008, resulting in multiple fatalities. Runway excursions continue to be a major threat to aviation safety.

3.2 General runway excursion trends

To identify long-term trends in runway excursions, accident records for the decade 1998 to 2007 were obtained from the Ascend World Aircraft Accident Summary (WAAS). This data represents all known major aircraft accidents that have occurred worldwide during this period.

Over the 10-year reporting period, 141 runway excursion accidents were identified involving the worldwide Western-built commercial jet aircraft fleet. Of those 141 accidents, 120 (about 85 per cent) occurred during the landing phase of flight. Nine

per cent of the remaining excursion accidents occurred during takeoff, and six per cent occurred as the result of an rejected takeoff.

The data analysis in this section will focus only on those 120 accidents.

The key findings from this data indicated the following.

- Nine per cent (n = 11) of runway excursion accidents resulted in fatal injuries to flight crew, passengers or bystanders.
- Most excursions occurred in Asia (30 per cent), Africa (17 per cent), and South America (16 per cent) – areas of the world where the overall accident rates are generally lower compared with Australia. In total, these three continents accounted for about two-thirds of all runway excursion accidents between 1998 and 2007 (Figure 2), despite accounting for less than 30 per cent of worldwide aircraft departures (Ranter, 2006).
- The remaining 37 per cent of runway excursion accidents occurred in North America, Europe, the Middle East, the Pacific, and the Commonwealth of Independent States (CIS) - areas of the world where the overall accident rates are generally comparable with Australia.

Figure 2: Percentage of runway excursion accidents by continent

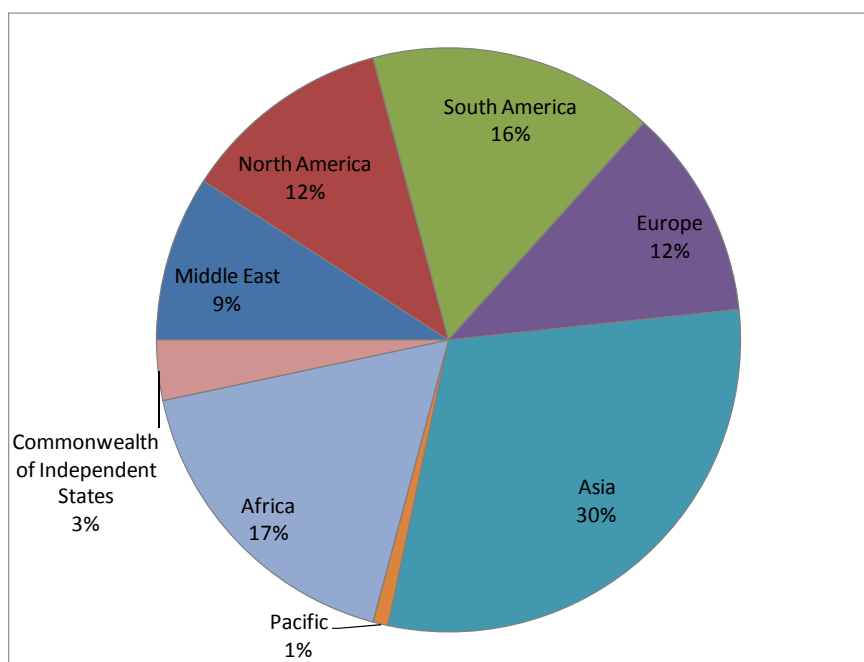

- One runway overrun and one runway veer-off involving Australian civil-registered (VH-) commercial jet aircraft were recorded in Australia during this period. Both of those excursions occurred during the landing phase of flight. In addition, one runway overrun was recorded involving an Australian civil-registered (VH-) commercial jet aircraft at an overseas airport.

Based on the Ascend WAAS data, the average rate of commercial aircraft runway excursion accidents between 1998 and 2007 was 14.1 per year. On average, 12 of those accidents occurred during the landing phase of flight, with take-off excursions accounting for only 2.1 accidents per year.

In terms of the excursion type, overruns dominated, accounting for 60 per cent of runway excursion accidents (n = 72), while the remaining 40 per cent (n = 48) were veer-offs.

Over the reporting period, the highest number of runway excursion accidents during landing was recorded in 1999, with 13 overruns and seven veer-offs recorded that involved Western-built commercial jet aircraft. This had consistently declined to six runway excursions by 2002. However, since this time, the numbers have fluctuated across the years, with an average of nine accidents per year for 2003 to 2007 (Figure 3). As a result, the overall average for the decade remained above the long-term National Transportation Safety Board and FAA estimate of 10 per year (FAA, 2007).

Figure 3: Frequency of runway excursion accidents during landing by type, 1998 to 2007

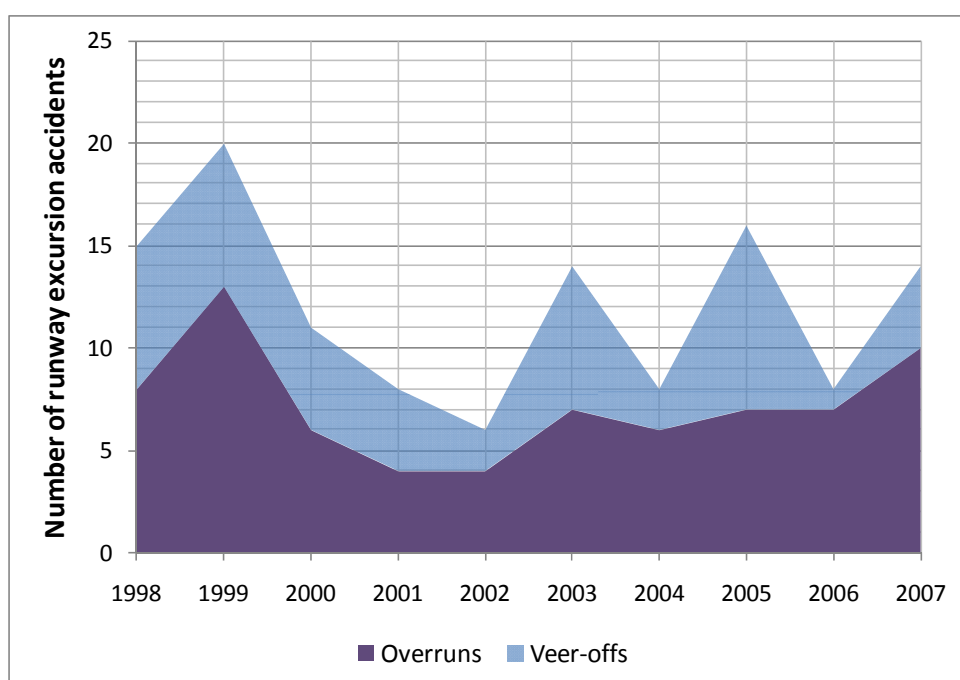

Of the 120 excursion accidents that occurred in the landing phase of flight between 1998 and 2007, 11 resulted in fatalities to the aircraft occupants with a total of 494 people fatally injured (Figure 4). Most of the fatal accidents were overruns (nine fatal accidents resulting in 401 fatal injuries, compared with two fatal veer-offs resulting in 93 fatal injuries). This is slightly lower than estimates by Boeing over the same period of 449 onboard fatalities and 89 fatalities on the ground due to runway excursion accidents (Boeing, 2008).

Figure 4: Frequency of runway excursion accidents during landing by outcome, 1998 to 2007

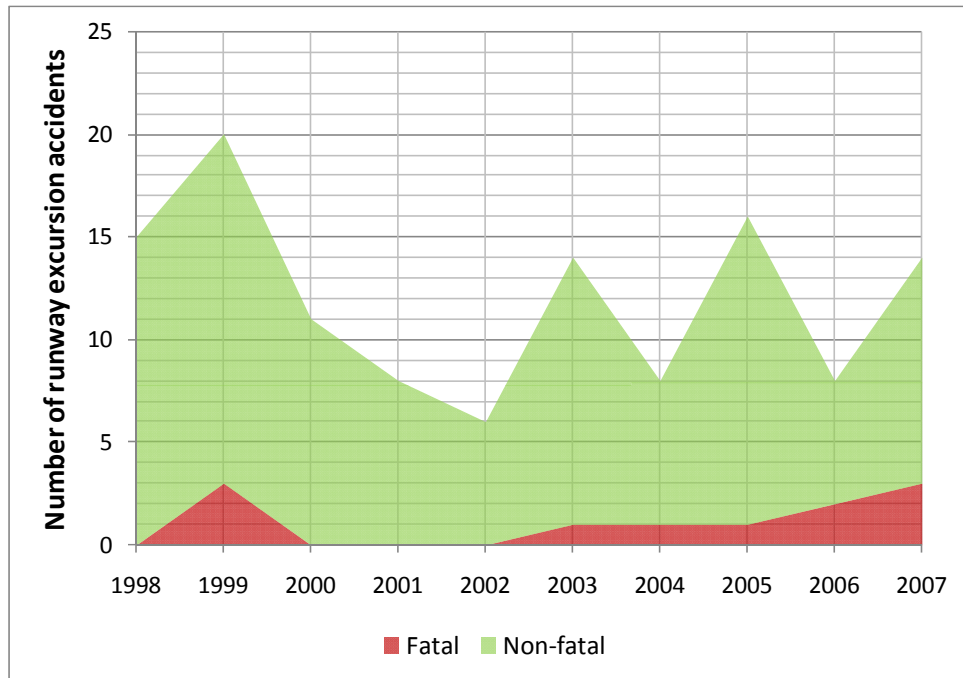

Accident investigations conducted by the Australian Transport Safety Bureau (ATSB) and other national aviation investigation bodies have identified that long landings, fast landings, and water-affected runways are often involved in runway excursion accidents. As is explored in the following chapters, these findings are supported by the Ascend WAAS overrun and excursion data for the period 1998 to 2007. In three runway excursions during the reporting period that involved Australian-registered commercial jet aircraft, at least one of those three factors contributed to each occurrence.

3.3 Major international runway excursions

Over the past decade, several major runway excursion accidents have occurred across the world. Many of those accidents have resulted in multiple fatalities to aircraft occupants and bystanders, severe aircraft damage from impact forces or post-impact fires, or damage to airport infrastructure and urban development surrounding the airport.

Notable runway excursion accidents that were identified in the Ascend WAAS data for the period 1998 to 2008 include:¹⁰

2008

- *Boeing 737-500, Denver International Airport, Colorado, United States.* The aircraft veered-off runway 34R at Denver International Airport during takeoff. The aircraft fell into a ravine alongside the runway edge, causing an undercarriage to collapse, separation of the number one engine, severe structural

¹⁰ Accident summaries sourced from Ascend (2007), Aviation Safety Network (2008), Lacagnina (2008a), NTSB (2008), and Wyatt (2008).

damage to the fuselage, and a post-impact fire. The runway surface was dry and free from snow at the time of the accident. Of the 115 people on board, 38 sustained injuries with at least two people seriously injured (Figure 5).

- *Learjet 60, Columbia Metropolitan Airport, South Carolina, United States.* The aircraft overran runway 11 during takeoff. Upon travelling past the end of the runway, the aircraft collided with the airport perimeter fence and localiser antenna, crossed a highway and collided with an embankment. Of the six people on board, four were fatally injured, and two sustained serious injuries.
- *Airbus A320, Tegucigalpa-Toncontin Airport, Honduras.* The aircraft overran runway 02 at on landing. The runway was water-affected at the time of the accident due to a tropical storm, and the aircraft landed with a tailwind component. Upon overrunning the end of the runway, the aircraft crossed a street, colliding with several cars before coming to rest against an embankment. Of the 124 people on board, three were fatally injured. Two persons on the ground were also fatally injured.
- *Boeing 747-200, Brussels Zaventem Airport, Belgium.* The Boeing 747-200 freighter aircraft overran runway 20 at Brussels Zaventem Airport following a high-speed rejected takeoff due to a multiple engine failure. The aircraft came to rest with the fuselage broken into three pieces, and in close proximity to a passenger railway line. Four of the five people on board received minor injuries.

Figure 5: Boeing 737-500 veer-off accident at Denver International Airport, Colorado, 20 December 2008



Source: Associated Press

2007

- *McDonnell Douglas MD-82, Phuket International Airport, Thailand.* The aircraft attempted to land in heavy rain and crosswind conditions, bounced several times and veered off the runway. The aircraft collided with an embankment and a stand of trees before a fire broke out. Of the 130 people on board, 90 persons sustained fatal injuries, and the aircraft was destroyed by the post-impact fire.

- *Airbus A320, Congonhas-Sao Paulo International Airport, Brazil.* The aircraft landed on a wet runway and was not stopped before the runway end. The aircraft overran the runway, crossed a major road, and collided with a warehouse. Of the 187 people on board, there were no survivors, and 12 people on the ground were killed. The aircraft was destroyed by impact forces and a post-impact fire.
- *Embraer ERJ-190, Simón Bolívar Airport, Santa Marta, Colombia .* Following a go-around, the aircraft landed in windy conditions and veered-off the side of the runway. The aircraft slid down an embankment and came to rest in the Caribbean Sea. Of the 59 people on board, there were no fatal injuries.
- *Boeing 737-400, Adisucipto Airport, Yogyakarta, Indonesia.* The aircraft landed hard on the runway following a steep and fast approach, bouncing several times before touching down halfway along the runway. The aircraft did not stop before the runway end and overran across a road into an embankment. Of the 140 people on board, 21 persons sustained fatal injuries, and the aircraft was destroyed by a post-impact fire.
- *Embraer ERJ-170, Cleveland-Hopkins International Airport, Ohio, United States.* The aircraft landed on a snow-covered runway following a non-precision approach. The flight crew had difficulty controlling the aircraft during the landing roll due to gusting winds, and could not decelerate the aircraft despite the use of maximum pedal braking and reverse thrust. The aircraft overran the runway and collided with a fence 150 ft beyond the end of the runway. Of the 75 people on board, three passengers sustained minor injuries. The aircraft was substantially damaged, suffering a partial undercarriage collapse during the overrun.

2005

- *Airbus A340-300, Toronto Pearson International Airport, Ontario, Canada.* The aircraft landed in severe thunderstorm conditions, touching down approximately halfway down the runway. The aircraft did not stop before the runway end and overran into a ravine. Of the 309 people on board, there were no fatalities, however, 11 persons were seriously injured, and the aircraft was destroyed by impact forces and a post-impact fire.
- *Boeing 737-700, Chicago Midway International Airport, Illinois, United States.* The aircraft landed beyond the touchdown zone on a snow-covered runway, and was not stopped before the end of the runway. The aircraft overran the airport boundary and onto a road intersection, impacting with several cars. Of the 103 people on board, there were no fatalities. On the ground, one person was fatally injured and five sustained serious injuries. There was significant damage to the aircraft, private property and surrounding urban areas.

2000

- *Boeing 737-300, Burbank-Glendale-Pasadena Airport, California, United States.* The aircraft landed long on the runway following a steep and fast approach, and was not stopped before the runway end. The aircraft overran the airport boundary and came to rest on a major road, in close proximity to a petrol station. Of the 142 people on board, there were no fatalities. Two persons were seriously injured, and there was significant damage to the aircraft and surrounding urban areas.

1999

- *Boeing 747-400, Don Mueang International Airport, Bangkok, Thailand.* The aircraft landed in heavy rain following a fast approach. Reverse thrust was not used to decelerate the aircraft after touchdown. The aircraft aquaplaned, and was not stopped before the runway end. The aircraft overran through the localiser antenna and came to rest just short of a golf course. Of the 410 people on board, there were no fatalities or serious injuries reported, however, the aircraft sustained significant damage. This accident involved an Australian registered aircraft and is summarised in more detail in Section 3.4.
- *McDonnell Douglas MD-82, Little Rock National Airport, Arkansas, United States.* The aircraft attempted to land in severe thunderstorm and crosswind conditions, touching down long. The aircraft could not be stopped before the end of the runway, and overran down an embankment before colliding with a group of steel runway light stanchions. Of the 145 people on board, 11 persons were fatally injured, 44 were seriously injured, and the aircraft was destroyed by impact forces and a post-impact fire.

3.4 Australian runway excursions

In the period 1998 to 2007, the ATSB recorded three runway excursions that involved Australian registered (VH-) aircraft, occurring within Australia and overseas. One of those runway excursions was a veer-off, and the remaining two were runway overruns.

The only accident of these three excursions was the runway overrun involving an Australian-registered aircraft that was operating a commercial passenger service to Bangkok, Thailand (described below). In this accident, there were no serious injuries to passengers or crew; however, the aircraft sustained substantial damage.

The other two excursions (described below) were classified as *serious incidents*¹¹ as they resulted in no injuries to passengers or crew and minor or no damage to the aircraft.¹²

Boeing 747-400 overrun, Don Mueang (Bangkok) International Airport, Thailand, 23 September 1999

What happened?

On 23 September 1999, at about 2247 local time, the Boeing 747-400 aircraft overran runway 21L while landing at Bangkok International Airport, Thailand. The aircraft landed long and aquaplaned¹³ on a runway that was affected by water following very heavy rain, and was not stopped before the runway end. The aircraft suffered substantial damage after overrunning the runway at 96 kts, colliding with

¹¹ A serious incident is defined by the International Civil Aviation Organization Annex 13 as ‘an incident involving circumstances indicating that an accident nearly occurred.’ For the definition of an accident, see footnote 6 on page 19.

¹² As these two runway excursions were not *accidents*, they were not included in the analysis of the 120 landing runway excursion accidents described in Section 3.6 and Chapters 4, 5, 6 and 7.

¹³ Aquaplaning refers to the aircraft partially or totally losing contact with runway as the tyre rides above the runway surface on a film or wedge of standing water (FSF, 2000f).

an instrument landing system (ILS) localiser antenna that initiated the collapse of the nose and right wing landing gear. This allowed the aircraft to adopt a slight right wing low attitude, resulting in the right inboard and outboard engine nacelles contacting the ground. The aircraft eventually came to rest on a road 220 m from the end of the stopway¹⁴ (Figure 6). None of the three flight crew, 16 cabin crew or 391 passengers reported any serious injuries. The accident was investigated by the ATSB (ATSB, 2001).

How did it happen?

The accident occurred at night time and in poor weather conditions, with heavy rain and thunderstorms in the vicinity of the airport. Braking action on the runway had been reported as 'good' by the crew of a preceding aircraft. This information was reported to the flight crew by air traffic control. At the time of the accident, runway 21L was not equipped with runway centreline or touchdown zone lighting, and was not grooved¹⁵.

The first officer was the handling pilot for the flight. In accordance with the operator's procedures at the time of the accident, the flight crew elected to use a configuration of 25 degrees of flaps and idle reverse thrust for the approach and landing.

The flight crew did not notice or experience any adverse weather during the approach until the aircraft entered very heavy rain as it descended through 200 ft on the final approach. At this point, visibility was reduced, and the aircraft began to deviate above the glide path. The aircraft crossed the runway threshold at 169 kts and at a height of 76 ft. While these parameters were within the operator's limits, they were outside the target threshold crossing height and airspeed for a stabilised approach (44 ft and 154 kts). As a result, the aircraft landed over 600 m beyond the touchdown zone.

When the aircraft was 10 ft above the runway, the captain instructed the first officer to go around. As the first officer advanced the engine thrust levers, the main wheels of the aircraft touched down. Due to the standing water present on the runway surface, the aircraft tyres aquaplaned, limiting the effectiveness of pedal braking. At this point, the captain cancelled the go-around without announcing his intentions to the other flight crew members. This caused confusion on the flight deck, and contributed to the pilots not selecting reverse thrust during the landing roll to decelerate the aircraft. With the prevailing runway conditions and the absence of reverse thrust, there was no prospect of the flight crew stopping the aircraft in the runway distance remaining after touchdown.

Why did it happen?

The ATSB investigation identified a number of contributing factors to the overrun:

- the flight crew did not use an adequate risk management strategy for the approach and landing. In particular, they did not consider the potential for the runway to be contaminated by water, and consequently did not identify appropriate options and/or landing configurations to deal with the situation. That

¹⁴ A stopway is an area at the end of a runway prepared as a suitable area in which aircraft can be stopped in the case of a rejected takeoff.

¹⁵ Grooving of runways allows water to drain away to the edges of the runway more quickly, reducing the build up of standing water, and lowering the risk of aquaplaning.

error was primarily due to the absence of appropriate company procedures and training;

- the first officer did not fly the aircraft accurately during the final approach;
- the captain cancelled the go-around decision by retarding the thrust levers;
- the flight crew did not select (or notice the absence of) idle reverse thrust;
- the flight crew did not select (or notice the absence of) full reverse thrust; and
- the runway surface was affected by water.

The ATSB also identified some organisational risk controls that were less than adequate at the time of the accident, but could have prevented the aircraft from landing in a configuration that was not safe for the prevailing weather and runway conditions:

- company-published information, procedures, and flight crew training for landing on water-affected runways were inadequate; and
- flight crew training in evaluating the procedural and configuration options for approach and landing was inadequate.

The operator addressed all of the safety recommendations made by the ATSB following the accident.

Figure 6: Boeing 747-400 overrun accident at Bangkok International Airport, Thailand, 23 September 1999



Source: ATSB, 2001

***Boeing 737-800 overrun, Darwin International Airport, Northern Territory,
11 June 2002***

What happened?

On 11 June 2002, a Boeing 737-800 aircraft overran runway 29 at Darwin International Airport at night following an unstabilised approach, and came to rest 44 m into the 90 m runway end safety area. There were no injuries, and the aircraft was not damaged. This serious incident was investigated by the ATSB (ATSB, 2004).

How did it happen?

At the time of the incident, runway 29 was operating with a threshold that was temporarily displaced 1,173 m beyond the permanent threshold, due to works at the eastern end of the runway. As a result, the runway rollout length was less than normal. The temporary threshold was equipped with threshold lights, and approach path guidance was provided by a portable precision approach path indicator (PAPI).

At approximately 9.5 NM from touchdown, the aircraft's rate of descent began to decrease, allowing the aircraft to drift above the glide path and become unstabilised. The flight crew conducted a number of steps to increase the rate of descent to return to the correct glide path, such as extending the landing gear, late extension of the flaps, and use of the idle thrust setting throughout the approach and landing phases.

The increase in the descent rate allowed the aircraft to come close to regaining the correct profile (20 ft above the normal threshold crossing height), however, this came at the expense of an excessive touchdown speed. At 100 ft above the runway, the approach speed was 29 kts above the reference speed (V_{REF}). While the aircraft touched down at 140 kts, it floated above the runway for 650 m to bleed off excess airspeed, landing 1,165 m from the displaced threshold.

Following touchdown, the aircraft was decelerated normally. As the aircraft approached the end of the runway, it began to veer to the left of the centreline. The aircraft ran over the end of the runway at 35-40 kts, and travelled 44 m into the runway end safety area. The flight crew then commenced a taxi to the terminal, unaware that the aircraft had overrun the runway end.

Why did it happen?

The ATSB investigation identified a number of contributing factors to the overrun:

- the captain did not fly the aircraft accurately during the final approach;
- the captain did not comply with the stabilised approach requirements stipulated in the operator's standard operating procedures (SOPs);
- the captain pressed on with an unstabilised approach and did not conduct a go-around, despite a number of visual cues to both pilots that the aircraft was in an unstabilised approach; and
- the first officer did not announce that the approach was unstable and instruct the captain to go around.

Boeing 737-300 veer-off, Darwin International Airport, Northern Territory, 19 February 2003

What happened?

On 19 February 2003, a Boeing 737-300 aircraft landed at night on runway 29 at Darwin International Airport following a normal, stabilised approach. The aircraft touched down close to the right edge of the runway and veered-off the sealed runway surface. The captain returned the aircraft back to the runway during the landing roll. There were no reported injuries to the passengers or crew. The aircraft sustained minor damage from the ingestion of grass and fragments of the runway edge lights into the engines. The serious incident was investigated by the ATSB (ATSB, 2005).

How did it happen?

The runway condition was reported as 'wet', however, the braking action was reported as 'good'. Runway 29 was 3,354 m (11,000 ft) long and grooved (in the central 45 m), however, at the time of the incident, it was not equipped with centreline or touchdown zone lighting, nor was it required to be. The International Civil Aviation Organization (ICAO) and the Civil Aviation Safety Authority (CASA) had recommended that centreline lighting be provided on runways where the width between the runway edge lights was greater than 50 m. Runway 29 was 60 m (197 ft) wide, which was significantly wider than other Australian runways used by the operator's Boeing 737 fleet. This meant that the visual cues and runway perspective available to the flight crew were different from those normally experienced.

Why did it happen?

The ATSB analysis of the flight data recorder (FDR) information showed that the autopilot was disengaged about 20 seconds prior to touchdown, a few seconds after reaching the decision height. At this point, the aircraft was correctly established on the glideslope and localiser, however, it began to deviate above the glide path shortly afterwards.

About 13 seconds prior to touchdown, the FDR recorded some small control column inputs that resulted in the aircraft banking slightly to the right, followed by the application of left rudder. Those coordinated control inputs caused the aircraft to adopt a left heading as expected by the flight crew, however, this also introduced a sideslip and corresponding drift to the right that was not perceived by the flight crew. In the final 70 ft of descent prior to the touchdown, the control column movements caused the flight spoilers on the right wing to deploy, resulting in the aircraft drifting further to the right.

The aircraft's deviation from the runway centreline during the final stages of the flight was undetected and uncorrected by the captain (who was initially the pilot monitoring, with the first officer the pilot flying, before taking over as the pilot flying during the later stages of the approach). This could indicate that the visual cues available during the final stages of flight were insufficient for the crew to safely land the aircraft. Significantly, the captain did not recognise that those visual cues had diminished to such a point where he was unable to control the lateral position of the aircraft over the landing runway, until after the aircraft had touched down. At this point, the captain heard the aircraft wheels striking runway lights and noticed that the runway edge lights were tracking down the centre of the windscreen

frame, and applied differential braking to bring the aircraft back towards the runway centreline.

The ATSB investigation following the incident identified a number of contributing factors to the veer-off:

- the captain did not detect or correct the aircraft's deviation from the centreline during the final approach;
- the visual cues available to the flight crew in the final stages of the flight were insufficient for the pilot to safely land the aircraft, or control the aircraft's lateral position over the runway; and
- that the presence of runway centreline lighting would have increased the visual cues available to the flight crew, and assisted with the recognition of the developing sideslip and lateral deviation from the centreline.

3.5 Flight Safety Foundation review of approach and landing accidents

As part of their program to reduce approach and landing accident rates, the Flight Safety Foundation (FSF) ALAR Task Force studied how frequently different factors contributed to *approach and landing accidents* (approach and landing accidents include, among others, runway excursions and CFIT accidents). Those factors were classified according to a taxonomy developed by the United Kingdom CAA (Table 1). In many cases, more than one factor contributed to the accident or incident (hence the percentage totalling more than 100).

The FSF study found that, from a sample of 76 approach and landing accidents and serious incidents worldwide between 1984 and 1997, the majority of contributing factors identified were flight crew technique or decision-related. These included:

- judgement, awareness and airmanship errors, particularly related to approach path deviations, the position and attitude of the aircraft, and the ability of the flight crew to fly a stabilised approach;
- deviations by the flight crew from the operator's SOPs, such as continuing a landing following an unstabilised approach rather than conducting a go-around;
- crew resource management (CRM) issues, including less than adequate monitoring of the approach characteristics by the first officer or the pilot not flying; and
- delayed flight crew action in deciding whether a go-around was required or not, selecting an appropriate aircraft configuration for landing, or in decelerating the aircraft after touchdown (Khatwa & Helmreich, 1999).

Most of the factors below have the potential to contribute to an unstabilised approach, and in some cases a failure to go around following an unstabilised approach.

Table 1: Frequent contributing factors to approach and landing accidents

Contributing factor	Per cent of accidents
<i>Judgement/airmanship errors</i> <ul style="list-style-type: none"> • landing following an unstabilised approach • failure to conduct a missed approach and go-around • executing a non-precision approach in demanding conditions 	73.5
<i>Deviation from SOPs</i> <ul style="list-style-type: none"> • omitting checklists or standard callouts • failure to check radio altimeter 	72.4
<i>Failure to monitor/challenge (CRM breakdown)</i> <ul style="list-style-type: none"> • failure to initiate go-around • excessive speed, sink rate, or glideslope deviation 	63.2
<i>Less than adequate positional and altitude awareness</i>	51.3
<i>Flight handling difficulties</i> <ul style="list-style-type: none"> • in poor weather conditions • attempting to execute difficult air traffic control (ATC) clearances 	44.7
<i>Delayed flight crew action</i> <ul style="list-style-type: none"> • delayed aircraft configuration changes • delayed braking action • delayed go-around decisions • delayed action to stabilise approach 	44.7
<i>'Press-on-itis'¹⁶</i> <ul style="list-style-type: none"> • continuing an approach despite deteriorating weather • accepting demanding ATC clearances 	42.1
<i>Slow and/or low on approach</i>	35.5
<i>Too high and/or fast on approach</i>	30.3

Source: Khatwa & Helmreich, 1999

Following this study, the FSF established a new, simpler taxonomy for identifying contributing factors in approach and landing accidents (replicated in Appendix C). This taxonomy is based on four categories:

- flight crew technique and decision-related factors;
- performance-related factors;
- weather-related factors; and
- systems-related factors.

¹⁶ Press-on-itis is a term which is used to describe a decision by a flight crew to continue with their original landing plan, even though prevailing weather, runway, or other operational conditions suggest that another course of action would be more appropriate (i.e. deciding to 'go' in a 'no-go' situation) (Orasanu & Martin, 1998).

Press-on-itis and its role in runway excursion accidents is discussed further in section 4.4.

The FSF identified the following factors that were specifically involved in runway excursion accidents (FSF, 2000c).

In runway veer-offs, typical contributing factors might include:

- **Flight crew technique and decision factors** – incorrect crosswind landing technique (i.e. failure to correctly crab¹⁷ or de-crab the aircraft on approach), inappropriate use of differential braking or nosewheel steering, or exiting the runway at high speed.
- **Weather factors** – runway condition (e.g. ice, snow, standing water, rubber contamination), wind shear, crosswinds and tailwinds, inaccurate reporting of crosswind conditions or reverse thrust effect in a crosswind.
- **Systems factors** – asymmetric thrust or uncommanded differential braking.

In runway overruns, typical contributing factors might include:

- **Flight crew technique and decision factors** – unstabilised approach or extended flare resulting in a long or fast landing, poor visual contact with the runway during approach, not conducting a go-around following an unstabilised approach, bouncing on landing, delayed braking, inappropriate differential braking or non-use of reverse thrust, or failure to deploy ground spoilers.
- **Performance factors** – incorrect assessment of landing distance for prevailing weather and runway conditions, less than adequate awareness of approach and landing SOPs, or incorrect assessment of the effect of minimum equipment list (MEL) items on landing and braking performance.
- **Weather factors** – unanticipated runway conditions, inaccurate reporting of or unanticipated wind shear or tailwind conditions.
- **Systems factors** – loss of pedal braking or anti-skid systems, aquaplaning, uncommanded differential braking, or uncommanded asymmetric thrust.

3.6 Worldwide runway excursion accident analysis summary

Each of the 120 runway excursion accidents between 1998 and 2007 that occurred during the landing phase of flight was analysed to determine probable contributing factors. In the majority of excursions, several factors were identified that probably contributed to the accident. The contributing factors for 11 of the 120 accidents could not be determined from the information available (due to the lack of an accident report or because the accident investigation has not yet been completed). From the remaining 109 accidents, 343 contributing factors were identified.

Figure 7 provides a high-level breakdown of the prevalence of these contributing factors in runway excursion accidents. Figure 8 shows the number of accidents that involved at least one contributing factor from the FSF categories.

¹⁷ See Figure 26 on page 66 for a description of crabbing.

Figure 7: Total number of contributing factors (343) to all runway excursion accidents worldwide during the landing phase of flight, 1998 to 2007

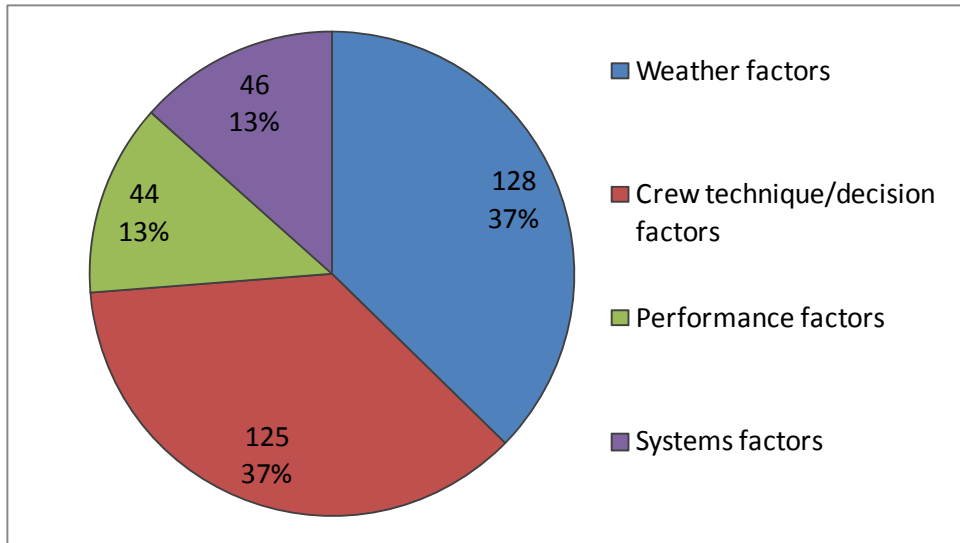
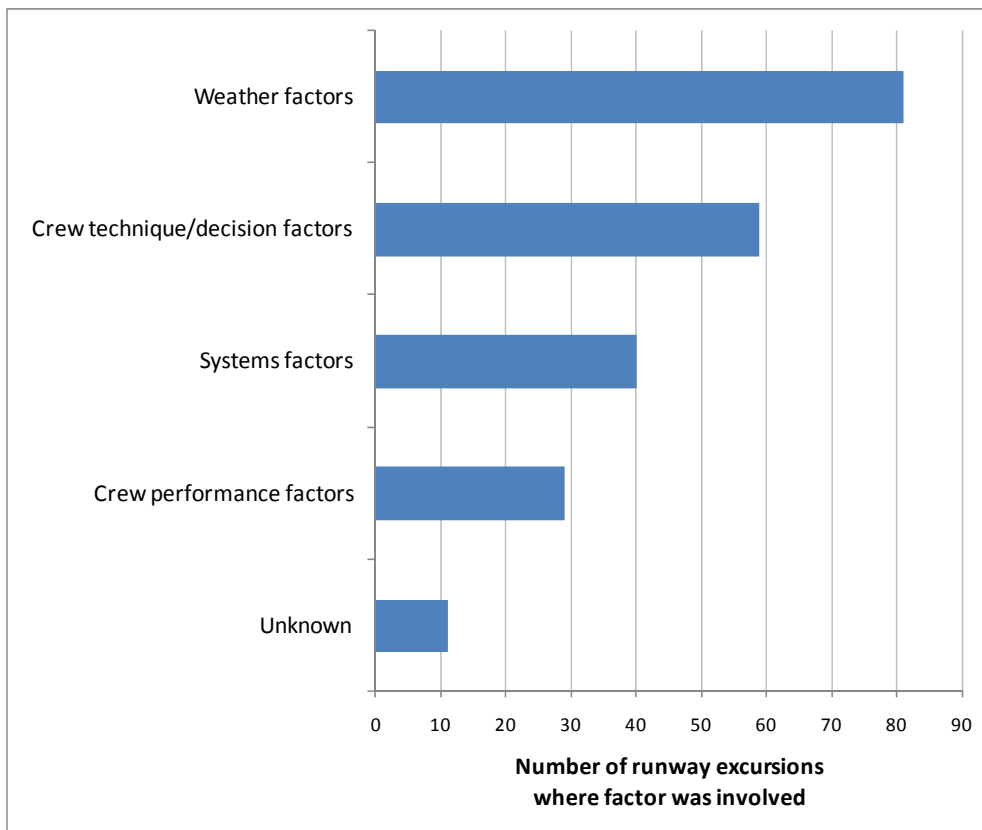

Figure 8: Number of runway excursion accidents worldwide on landing (120) involving at least one contributing factor, 1998 to 2007



An analysis of each of these factors is discussed in depth in Chapters 4, 5, 6 and 7. In summary, the categories presented in Figure 7 and Figure 8 included the following:

- flight crew technique and decision-related factors were present in 59 accidents, and accounted 37 per cent of all contributing factors identified. They were often the result of a long or fast landing following an unstabilised approach, which was, in turn, due to excess airspeed or deviation from the glide path during the approach. Delayed flight crew action in the use of braking devices is also a common crew technique/decision-related contributor to runway excursions. In veer-offs, incorrect crab technique or incorrect use of differential steering and reverse thrust was also present as a crew technique/decision-related factor;
- flight crew performance-related factors (such as incorrect assessment of required landing rollout length, flight crew awareness of MEL items, or less than adequate awareness of operator procedures) contributed to 29 accidents and 13 per cent of factors; and
- weather-related factors, such as water-affected runways, crosswinds and tailwinds, and inaccurate reporting of weather conditions existed in 81 accidents, the highest proportion of accidents of all the factors. However, like flight crew technique and decision-related factors, accounted for 37 per cent of all factors identified;
- systems-related factors (such as uncommanded differential braking/reverse thrust, and aquaplaning) were present in 40 accidents and contributed to 13 per cent of all contributing factors.

4

CREW TECHNIQUE AND DECISION-RELATED FACTORS IN RUNWAY EXCURSION ACCIDENTS

Flight crew techniques and decisions were on par with weather-related factors as the most common contributors to runway excursion accidents, accounting for 37 per cent of the 343 factors identified as contributing to the 120 runway excursions between 1998 and 2007 identified in the Ascend World Aircraft Accident Summary (WAAS), (Ascend, 2007). Crew technique or decision errors were identified as probable contributing factors in 59 of the 120 accidents.

Figure 9 presents a breakdown of the frequency of different types of flight crew technique/decision-related factors identified. The five most were:

- a long landing or extended flare;
- a decision to press on with an unstabilised approach and not conduct a go-around or diversion to another airport;
- a fast landing above the aircraft's approach reference speed (V_{ref});
- a deviation from the approach path or glideslope during final approach (resulting in an unstabilised approach); and
- less than adequate or intermittent visual contact with the runway on final approach and landing, often leading to a loss of spatial awareness and a deviation from stabilised approach parameters.

Figure 9: Breakdown of flight crew technique/decision-related factors across 59 runway excursions on landing, 1998 to 2007

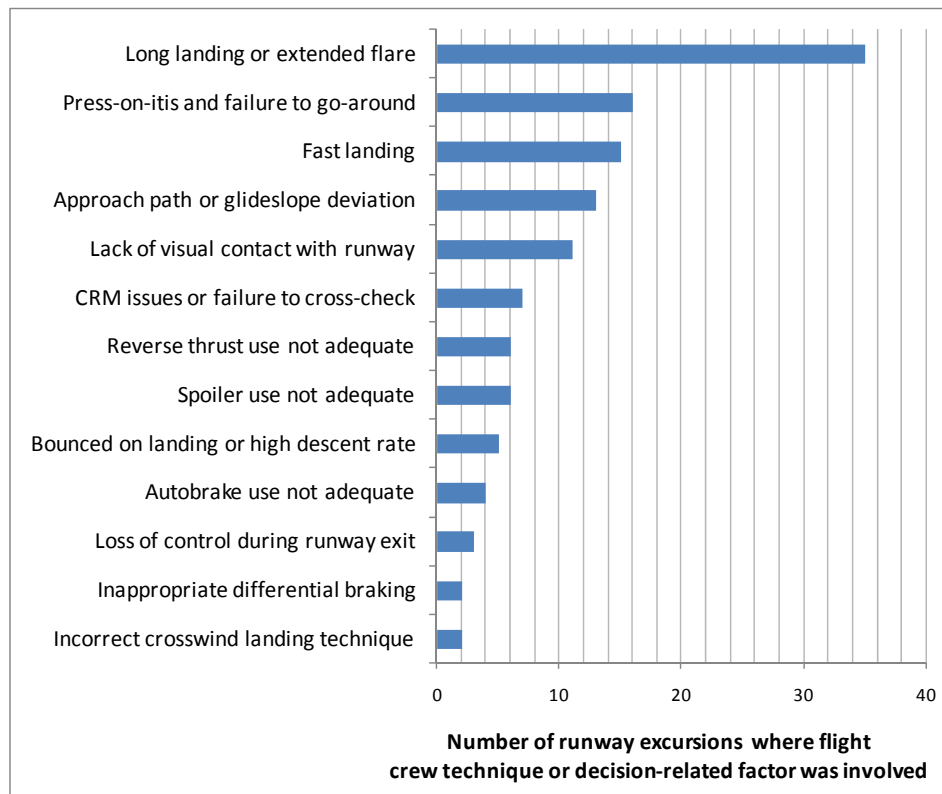

Delayed or incorrect use of braking systems by the flight crew was also a common contributor to flight crew technique and decision-related runway excursions.

This chapter discusses some of the most common flight crew technique and decision-related errors, and how they can increase the risk of an overrun or veer-off occurring.

4.1 Unstabilised approaches

Unstabilised approaches have been identified as a critical safety factor in many major runway excursion accidents, including the 1999 Boeing 747-400 overrun in Bangkok, Thailand, the 2005 Airbus A340 overrun at Toronto, Canada, and the 2007 Boeing 737-400 accident at Yogyakarta, Indonesia.

What are unstabilised approaches?

An **unstabilised approach** occurs when any of the following parameters are **not achieved** during the final approach:

- the aircraft is on the correct approach path (generally a three-degree vertical approach path);
- only small changes in heading and pitch are required to maintain the correct flight path;
- a constant angle glide path towards a predetermined point on the runway (usually the touchdown zone or aiming point);
- the aircraft is in the correct landing configuration, with an appropriate power setting not below the minimum power for approach defined in the aircraft operating manual;
- a constant descent airspeed no more than 20 kts above the landing reference speed (V_{ref}), and not less than V_{ref} ; and
- a constant descent rate (no more than 1,000 ft/min).

Conversely, an approach that maintains all of these parameters is a stabilised approach.

All aircraft on approach must be stabilised by 1,000 ft above airport elevation in instrument meteorological conditions (IMC), or by 500 ft in visual meteorological conditions (VMC). Where this cannot be achieved, the flight crew must conduct an immediate go-around.

Source: FAA, 2007; FSF, 2000b

Figure 10 depicts the aspects of a stabilised approach. The approach should be stabilised at 1,000 ft in IMC conditions or 500 ft for VMC conditions. The aircraft should be at a height of approximately 50 ft when crossing the runway threshold, prior to the flare, and landing in the touchdown zone (generally 1,000 ft beyond the threshold).

Figure 10: Aspects of a stabilised approach

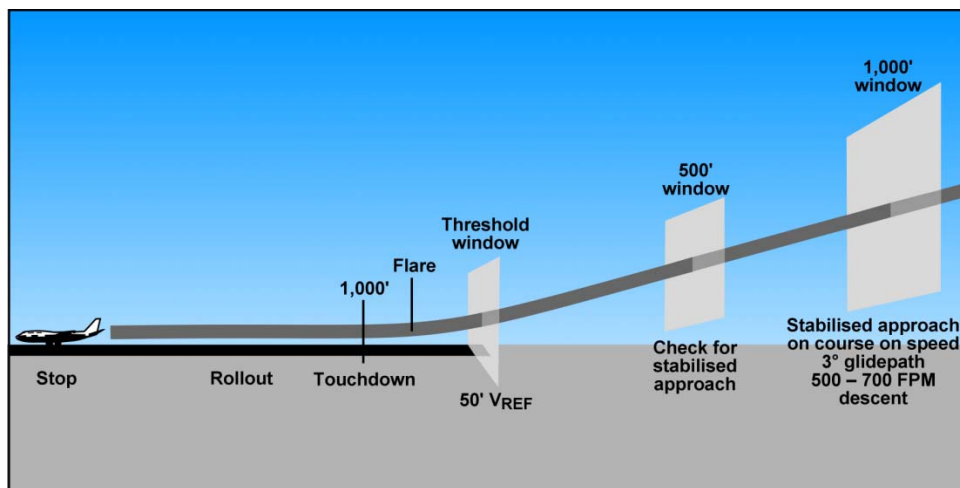

Source: FAA, 2007

If the aircraft is flying a guided approach using an instrument landing system (ILS), some additional parameters must be met to ensure a stabilised approach (FSF, 2000b):

- All ILS approaches – the aircraft must be flown within one dot of the glideslope and localiser.
- Category II or III ILS approach – the aircraft must be flown within the expanded localiser band.

During circling approaches, the aircraft should be wings-level on final approach at 300 ft above airport elevation.

Stabilised approaches are safer because in addition to increasing the flight crew's overall situational awareness, they also:

- provide defined limits for deviations from approach parameters, and also specify minimum stabilisation heights at different points in the approach to give the flight crew several opportunities to assess whether a go-around is required or not;
- ensure predictable landing performance that is consistent with published performance;
- allow the flight crew more time and attention to monitor air traffic control communications, assess local weather conditions, and check that aircraft systems are working and correctly configured for landing; and
- allow more time for the pilot not flying to assist with, and cross-check, the flying pilot's actions.

4.1.1 Unstable approaches and runway excursions

An unstabilised approach is an undesired aircraft state that places additional and unnecessary pressure on the flight crew during one of the most critical phases of flight, and reduces the time available to complete checklists and sufficiently prepare for the landing. This can lead to reduced safety margins if mismanaged or not identified by the flight crew.

Unstabilised approaches can result in further undesired aircraft states following the touchdown.

- **‘Fast’ landing** - the aircraft landing at a higher than normal airspeed due to the faster approach speed. In some cases, excessive airspeed may be the result of a steep approach angle. If the descent rate is too high, the aircraft may bounce on landing, increasing the landing rollout length.
- **‘Long’ landing** – an aircraft that is too high on the approach may cross the runway threshold higher than the normal threshold crossing height of 50 ft, often resulting in a landing beyond the intended touchdown point (see Section 4.2).
- **Extended flare** – the flight crew may bleed off excess airspeed by extending the flare prior to touchdown, resulting in a long landing (see Section 4.2).
- **Off-centreline landing** – an approach that is laterally displaced increases the chance that the aircraft lands left or right of the runway centreline, increasing the risk of a veer-off.

While not all unstabilised approaches result in long landings, it is likely that the risk of one is increased. The chance of a long landing may also be influenced by the type of approach procedure used. Van Es (2005) has reported that unpublished flight data collected by the Dutch National Aerospace Laboratory (NLR) shows that the mean distance from the runway threshold to the touchdown point is about 30 per cent longer during a manual instrument landing than a precision approach.

The use of precision approach systems¹⁸, such as an ILS, may not reduce the risk of a runway excursion accident. Analysis of the 120 runway excursion landing accidents recorded in the Ascend WAAS between 1998 and 2007, showed that of the 54 excursions in which the approach type was known, 52 per cent (n = 28) followed an ILS approach. Of the remaining non-precision approaches, visual approaches and very high frequency omni-directional radio range (VOR) approaches accounted for half each.

Unstabilised approaches are often the consequence of a number of flight crew errors, and have been cited as contributing factors in approximately 30 per cent of all approach and landing accidents (Khatwa & Helmreich, 1999).

A univariate analysis of the 120 runway excursion accidents that occurred on landing between 1998 and 2007, revealed that at least 55 of these accidents (46 per cent) involved elements of an unstabilised approach, and/or undesired states that can result from an unstabilised approach:

- 35 accidents (29 per cent) involved a reported ‘long’ landing or extended flare;
- 18 accidents (15 per cent) involved a reported ‘fast’ landing, and/or a loss of control after touchdown due to an excessive airspeed;

¹⁸ A precision approach is an instrument approach that provides both vertical and lateral guidance.

- 13 accidents (11 per cent) involved either a lateral (left/right) or vertical (too high/too low) deviation from the approach path or glideslope;
- 11 accidents (nine per cent) involved the flight crew having poor visual contact with the runway during the final approach; and
- Five accidents (four per cent) involved the aircraft bouncing on touchdown, due to an excessive descent rate.

4.1.2 Causes and recovery from unstabilised approaches

Analysis by the Flight Safety Foundation (FSF) shows that frequent factors that contribute to an unstabilised approach are (FSF, 2000b):

- overconfidence, less than adequate vigilance of deviations from stabilised approach parameters, and press-on-itis, especially at airports that are familiar to the flight crew;
- less than adequate flight crew coordination to correctly set up the approach;
- task distraction during the approach (such as flight management computer programming tasks);
- inadequate awareness of wind conditions and its effect on airspeed and glide path deviations (vertical deviations in tailwind conditions due to increased airspeed, and horizontal deviations in crosswinds);
- the presence of visual illusions;
- less than adequate cross-checking of stabilised approach parameters by the pilot not flying; and
- accepting demanding or incorrect traffic clearances from air traffic control, leading to high workload conditions, or that require the flight crew to fly an approach that is too high or too fast.

Unstabilised approaches can be prevented through a continuous process of monitoring the stabilised approach parameters, and correcting any deviations.

The FSF suggests a strategy of *anticipate, detect, correct, and decide*:

- **Anticipate** – some factors that are likely to result in an unstabilised approach can be anticipated and avoided. For example, pilots and air traffic controllers should avoid situations where the flight crew are required to rush the approach. Pre-approach briefings can also provide an opportunity for the flight crew to discuss factors such as non-standard altitude, airspeed restrictions, and engine thrust management.
- **Detect** – minimum stabilisation heights and defined maximum deviation limits for the stabilised approach parameters ensure that the flight crew have a common reference for how the approach should be monitored to ensure it remains stabilised. Effective monitoring is assisted by reducing workload and distractions on the flight deck, such as late briefings, unnecessary radio calls and actions, and violations of the ‘sterile cockpit’ rule¹⁹.

¹⁹ Sterile flight deck rules outline when all flight crew activities shall be strictly confined with the operation of the aircraft.

- **Correct** – it is important that positive corrective actions are taken before deviations from stabilised approach parameters become excessive, and place the aircraft into a challenging or hazardous situation. Corrective actions might include timely use of speed brakes or landing gear to correct airspeed or altitude deviations, or extending the upwind or downwind legs of the circuit.
- **Decide** – if the approach is not stabilised when the aircraft reaches the minimum stabilisation height, or if deviations from the stabilised approach parameters are beyond limits, a go-around must be conducted immediately.

4.2 Too fast, too long

Of the 120 runway excursion accidents on landing between 1998 and 2007 analysed from the Ascend WAAS, 34 per cent (n = 41) involved long and/or fast landings. There were:

- 25 accidents involving a long landing and/or extended flare;
- 11 accidents involving both a long and fast landing;
- five accidents involving a fast landing only; and
- three accidents involving the aircraft travelling too fast on the runway after touchdown, resulting in a loss of control and a veer-off.

An unstabilised approach can increase the risk of a runway excursion, in particular an overrun, if the aircraft is travelling too fast or too high when it reaches the threshold crossing point. If the aircraft is higher than the normal threshold crossing height (TCH) of 50 ft, or travelling significantly faster (more than 5 kts) than the landing reference speed (V_{ref}) at the threshold crossing point as published in the Aircraft Flight Manual (AFM), an extended flare may be used to bleed off airspeed prior to the touchdown.

However, extended flares can result in long landings, significantly reducing the available runway length for landing. An extended flare typically uses up *hundreds or thousands of feet* – 2,500 ft (760 m) per every additional 10 kts according to FAA data (Figure 11). As a result, they frequently play a part in overruns. For example, a five per cent increase in the final approach speed above V_{ref} increases the landing distance by:

- 10 per cent if a normal flare and touchdown are conducted, and the excess airspeed is lost by decelerating the aircraft on the ground (300 ft increase per every 10 kts above V_{ref}); and
- 30 per cent if an extended flare is conducted, and the excess airspeed is bled off by floating (FAA, 2007; FSF, 2000c).

Figure 11: Effect of an extended flare on landing distance

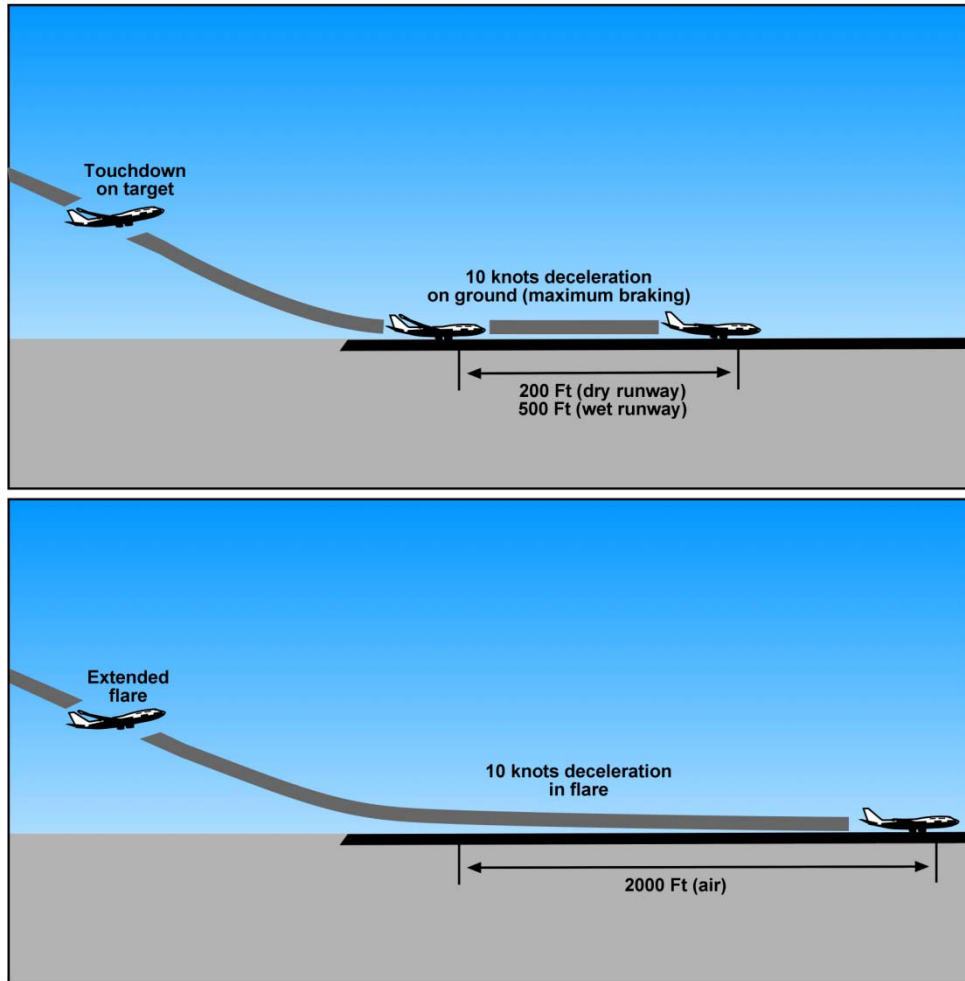

Source: FAA, 2007

All of these distances increase further if the runway is water-affected or contaminated (discussed in Section 6.3).

Crossing the threshold point slightly higher than the normal TCH has similar effects on the landing distance (Figure 12). Every increase of 10 ft (3 m) in TCH adds a possible 200 ft (61 m) to the landing distance (FAA, 2007).

Figure 12: Effect of threshold crossing height (TCH) on landing distance

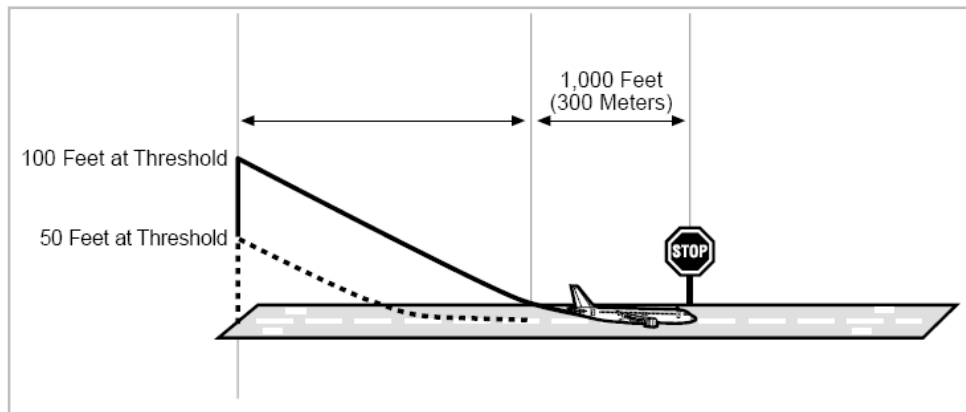

Source: FSF, 2000d

As long and/or fast landings reduce the runway length available for an aircraft to stop in, they also reduce the margin for other errors to manifest and be effectively managed (e.g. delayed flight crew action in braking) before an unsafe outcome such as a runway overrun occurs. In addition, long and fast landings increase the risk of other hazards such as wheel brake fires that pose not only a fire risk to the aircraft and its occupants, but also severely reduce braking action and the ability to stop the aircraft before the end of the runway.

In both the 1999 Boeing 747-400 overrun in Bangkok, Thailand, and 2005 Airbus A340 overrun in Toronto, Canada, long and/or fast landings resulted in both aircraft touching down over 1,000 m (3,280 ft) beyond their intended touchdown point. This left the flight crews with significantly less available runway ahead of them to stop the aircraft. Combined with challenging weather conditions that had already reduced the margin of safety for landing, an unsafe outcome resulted (ATSB, 2001; TSB, 2007). The Airbus A340 accident at Toronto is described further as a case study in Chapter 5.

4.3 Delayed braking and flight crew action

A contributing safety factor in all runway overrun accidents is the inability of the flight crew to stop the aircraft within the available runway length. While this may be related to a lack of runway length available after touchdown in which to stop the aircraft (as can be the case following a long or fast landing), aquaplaning or other reasons, delayed action by the flight crew in the use of braking devices to decelerate the aircraft is also a factor.

A FSF Approach and Landing Reduction (ALAR) Task Force study found that slow/delayed flight crew action in decelerating the aircraft during the landing rollout was a contributing factor in 45 per cent of all approach and landing accidents and incidents worldwide between 1984 and 1997 (FSF, 2000e).

Focussing only on runway excursion accidents, analysis of the 120 landing excursions that occurred between 1998 and 2007 identified that 30 per cent ($n = 36$) involved some form of delayed or incorrect use of braking devices by the flight crew, or inadequate identification and response to a failure in the aircraft braking system. Not all of those factors were crew technique or decision-related factors, for

example, there were also cases of system failures leading to uncommanded reverse thrust or differential braking.

In terms of crew technique or decision-related factors, 20 per cent of those factors were related to delayed braking and flight crew actions. Within this proportion (involving 17 individual accidents), inadequate cross-checking between flight crew members to ensure that braking devices were properly armed or being applied was the leading contributing factor to excursions (Figure 13). Inadequate use of autobrakes, reverse thrust or spoilers for the prevailing runway conditions and airspeed were also common factors involved in runway excursions. In veer-offs, inappropriate differential braking by the flight crew was involved in a small proportion of accidents.

Figure 13: Breakdown of flight crew technique/decision-related delayed braking and flight crew actions across 17 landing excursion accidents, 1998 to 2007

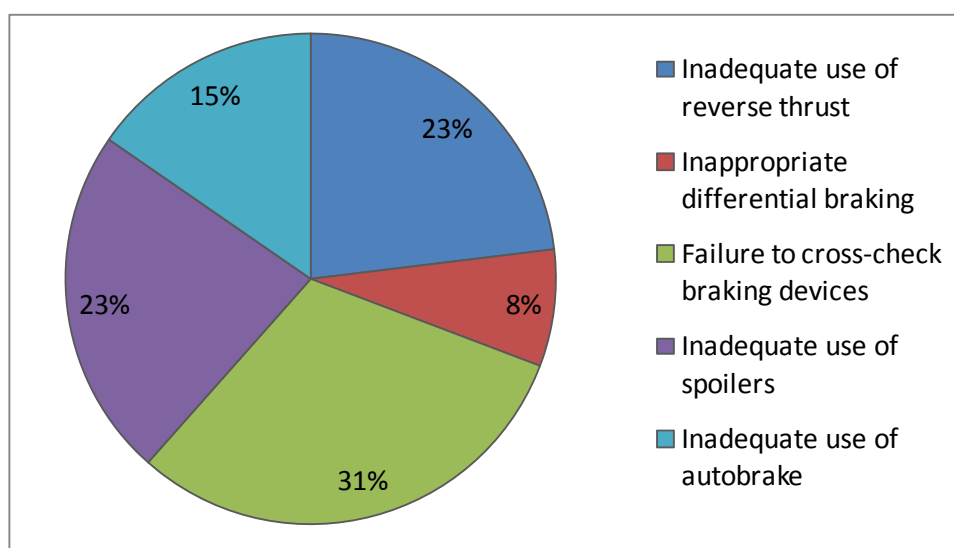

After touchdown, the aircraft relies on three forces to stop:

- Aerodynamic drag (includes parasitic drag²⁰, as well as drag from the air brakes, ground spoilers²¹, and flaps);
- Reverse thrust; and
- Rolling drag (friction between the tyres and the ground, mostly due to braking from the autobrake or manual foot braking).

Figure 14 shows the relative effectiveness of each of these forces at different aircraft speeds during the landing roll. At high ground speeds with the spoilers deployed, aerodynamic drag and reverse thrust provide approximately 50 per cent of the total force to stop the aircraft. At lower speeds, aerodynamic drag and reverse

²⁰ Parasitic drag is due to the friction between the air moving over the skin of the aircraft (fuselage, wings, engine nacelles etc.)

²¹ Spoilers are control surfaces on an aircraft's wings that can be raised to reduce lift and increase the rate of descent. Ground spoilers are fitted to many larger aircraft in addition to flight spoilers. These can only be used when the aircraft is on the ground, and act as air brakes to increase drag and help decelerate the aircraft during the landing roll.

thrust reduce to about 20 per cent of the stopping capability, with the contribution of wheel braking increasing to provide 80 per cent of the total stopping force (ATSB, 2004).

Figure 14: Typical decelerating forces during the landing roll

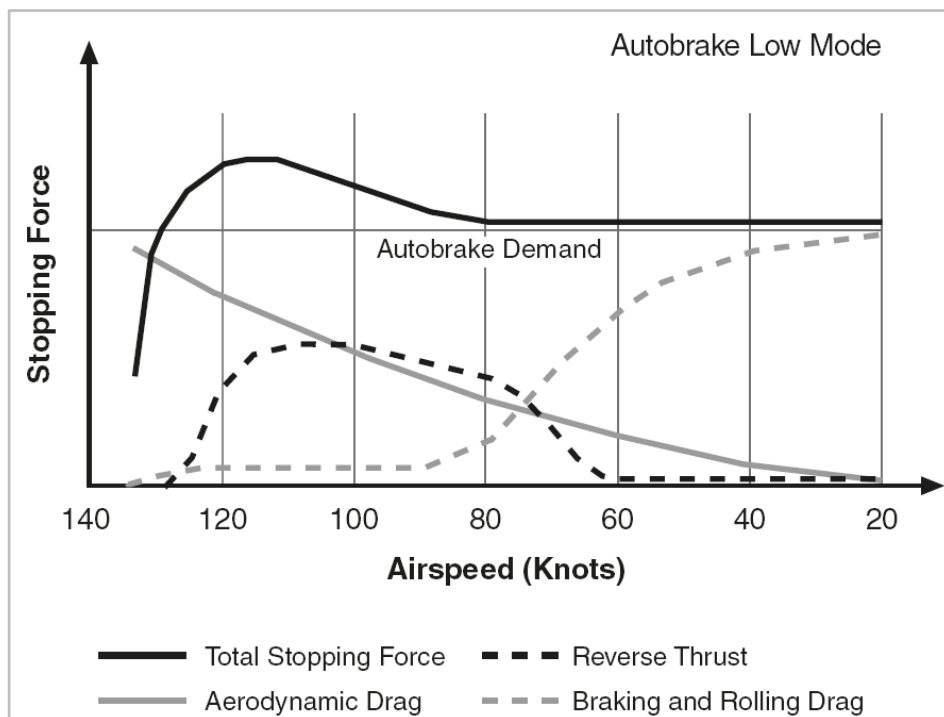

Source: FSF, 2000e

Aerodynamic drag and reverse thrust provide the most deceleration force just after touchdown, when the aircraft is still travelling at high speed. As the aircraft's speed reduces during the landing roll, aerodynamic drag and reverse thrust become less effective. This is due to:

- less drag being produced by the spoilers at lower aircraft speeds; and
- a lower air flow rate into the thrust reversers. The use of reverse thrust above idle power at lower speeds can lead to an engine compressor stall²² and a greater susceptibility for foreign object ingestion into the engines and resulting damage.

It is critical that ground spoilers are deployed and reverse thrust applied as soon as possible after the main landing gear has made contact with the runway, in accordance with the manufacturer standard operating procedures (SOPs). This high rate of initial deceleration also assists with wheel braking, as the autobrake will not operate until the total stopping force drops below the autobrake setting (or on a time delay). Where poor runway conditions exist (water-affected or contaminated), wheel braking is less effective. This is due to the reduced friction between the tyre and the runway, resulting in less rolling drag. Ensuring a firm positive touchdown is especially important in these conditions, as the deployment of reverse thrust and

²² A jet engine compressor stall occurs when the aerofoils within the engine compressor stalls due to abnormal airflow. Compressor stalls can be rotational (localised stall of some aerofoil blades, resulting in the efficiency of the compressor being temporarily reduced), or manifest as a surge/axi-symmetric stall (where the compressor is unable to work against the compressed air behind it, resulting in the sudden expulsion of compressed air back through the engine intake).

aerodynamic devices is triggered by weight on the wheels. These braking systems are unaffected by weather or runway conditions, and will provide the majority of the stopping force to decelerate the aircraft. The ground spoilers also act as lift dumping devices, increasing wheel loading by as much as 200 per cent (FAA, 2007). This results in increased wheel brake efficiency, improves tyre-to-ground friction and reduces the risk of aquaplaning (FSF, 2000e).

4.3.1 Causes of reduced or inappropriate deceleration

A number of slow/delayed or incorrect flight crew actions that reduce the ability to decelerate the aircraft have been identified in runway overruns (FSF, 2000e).

- Failure to auto-arm ground spoilers during pre-landing checklists. A failure to deploy the ground spoilers generally results in a 30 per cent increase in landing distance.
- Not making a positive touchdown, or delay in lowering the nosewheel onto the runway. Several aircraft systems used for deceleration on landing (including the spoilers, autobrake and thrust reversers) are activated by either compression on the main landing gear provided by the weight of the aircraft, or by sudden rotation of the nose wheel when it contacts the runway at touchdown ('spin-up'). These braking systems may not fully deploy if there is insufficient weight on the wheels.
- Ground spoilers not being armed while the aircraft was being operated with thrust reversers inoperative (on most large transport aircraft, the ground spoilers will auto-deploy when reverse thrust is selected).
- No visual confirmation, cross-checking and verbal call by flight crew that the ground spoilers have extended immediately after a positive touchdown has been made.
- Failure to use reverse thrust or any aerodynamic braking devices (reliance on the use of an extended flare or a high nose attitude on touchdown to achieve aerodynamic braking).
- Failure to select thrust reversers after touchdown, and engage maximum reverse thrust as soon as appropriate.
- Autobrakes not selected, or set to the incorrect mode for prevailing runway conditions according to the AFM (short runway, low visibility, contaminated runway etc.).
- Failure to monitor the autobrakes during the landing rollout and failure to switch to manual braking if required. Autobrakes may not be as effective as expected on wet or contaminated runways.

Delayed or incorrect flight crew action in decelerating the aircraft has also been a contributing factor in several runway veer-offs. These include the following.

- Asymmetric thrust, either through:
 - an inoperative thrust reverser on one side of the aircraft;
 - idle reverse thrust inadvertently applied to one engine, and positive reverse thrust on the remaining engines; or
 - positive forward thrust inadvertently applied to one engine, with idle or positive reverse thrust on the remaining engines.

- Brake unit inoperative (a 'cold brake'), leading to differential braking as the wheel brakes are applied.
- Wheel skid, and incorrect recovery via differential braking action on aircraft not fitted with anti-skid systems.
- Incorrect braking techniques in crosswind conditions (discussed in Section 6.2).

Case study: Boeing 737-700 runway overrun, Chicago

The fatal runway overrun accident of a Boeing 737-700 at Chicago Midway International Airport, Illinois on 8 December 2005, highlighted how delayed flight crew actions can combine with poor environmental conditions and a narrow margin for landing errors at inner city airports to produce a tragic outcome.

Figure 15: Boeing 737-700 overrun accident, Chicago Midway International Airport, 8 December 2005



Source: Chicago Tribune, 2005

What happened?

Following an ILS approach to runway 31C, the Boeing 737-700 touched down, failed to stop, and ran off the end of the runway. After leaving the runway the aircraft ran through a blast fence, continued through the airport boundary fence and impacted cars at an intersection just beyond. A child travelling as a passenger in one of the cars was killed and another car occupant was injured. There were no on board fatalities (Ascend, 2007).

How did it happen?

Runway 31C at Midway was 1,988 m (6,522 ft) long at the time of the accident. The runway was covered in snow. Following a landing 760 m (2,500 ft) past the runway threshold²³, the autobrakes (which had been set at maximum) activated. However, the captain reported that he could not select reverse thrust. Later, the first officer realised that the thrust reversers had not deployed and then activated them without difficulty. An analysis of the flight data recorder information showed that the thrust reversers were not activated until about 18 seconds after touchdown (Ascend, 2007).

Why did it happen?

The National Transportation Safety Board (NTSB) determined that the probable causes of this accident were:

- the flight crew did not use the available reverse thrust in a timely manner to safely slow or stop the aircraft after landing. The pilots' unfamiliarity with the aircraft's autobrake system distracted them from applying reverse thrust during the challenging landing;
- a long landing in poor runway conditions (i.e. night time, snow/ice on runway);
- a limited runway safety area beyond the departure end of runway 31C, due to the location of the airport in a built-up urban area; and
- less than adequate operator SOPs and flight crew training for autobrake operation, and calculating the required landing distance prior to arrival (NTSB, 2007).

4.4 'Press-on-itis' and flight crew management

In 1994, the NTSB published a report that examined flight crew involved in air carrier accidents between 1978 and 1990. Orasanu & Martin (1998) analysed the 37 accidents identified in the NTSB report and found that a common pattern among those accidents were the flight crew's decision to continue with their original plan, even though prevailing conditions suggested they should take another course of action. Basically, the flight crew decided to 'go' in a 'no-go' situation.

So-called press-on-itis can play a significant role in contributing to runway excursion accidents, controlled flight into terrain (CFIT), and other approach and landing accidents. The FSF ALAR study found that in 42 per cent of approach and landing accidents (ALAs), press-on-itis was a contributing factor. In addition, 78 per cent of all ALAs could have been prevented by a timely go-around (McKinney, 2006).

The Orasanu & Martin (1998) study also found four human factors that were possible contributors to flight crew decision errors identified in the NTSB report.

- **Ambiguity of information** – cues that signal a potential problem are not always apparent. For example, a flight crew may see that a runway is very wet and that storms exist close to the airport, but know that the aircraft ahead landed successfully, and as a result they commit to a landing. In ambiguous situations like this, the decision to abort the landing and conduct a go-around is harder for the crew to justify.

²³ The aircraft flight manual-recommended a touchdown zone of 1,000 to 2,000 ft beyond the runway threshold (NTSB, 2007).

- **Underestimating risk** – generally, when flight crews are faced with a problem, they assess the short-term and long-term risks. However, if the situation is similar to one that was previously experienced and dealt with successfully, there may be a tendency for the flight crew to adopt the same course of action. For example, if a flight crew lands in poor weather conditions frequently without incident, they may become desensitised to the risk associated with such a landing. This increases risk-taking behaviour, especially as a go-around is often seen as a ‘loss’ situation.
- **Goal conflicts** – organisational and social goals may exist that emphasise productivity, but conflict with safety. These may come from the airline (on-time arrivals and departures, fuel savings etc.), from other flight crew members (peer pressure to take risks or press-on with an unstabilised approach), or internally (the desire to get home, especially after the last flight of the day). Achieving these goals often appears to outweigh safety goals, especially in ambiguous conditions.
- **Unanticipated consequences** – as situations degrade, risk, stress, and time pressures may increase. This can lead to inadvertent flight crew actions, such as missing checklist items, or the delayed application of reverse thrust.

These factors may also contribute to other human performance errors that in turn become contributing safety factors to runway excursion accidents. Ambiguity of information has been known to contribute to loss of situational awareness, which can lead to unsafe landings or CFIT accidents (Edwards, Douglas & Edkins, 1998).

Goal conflicts are linked to crew resource management (CRM) issues, particularly where hierarchies exist within the flight deck. This can play a part in runway excursions where other flight crew members are aware of an unsafe aircraft configuration or approach, but fail to take action.

4.5 Go-arounds

The March 2007 overrun accident in Yogyakarta, Indonesia (see case study below), highlighted the need for operators to provide flight crews with appropriate training and guidance materials (including SOPs) that reinforce the serious consequences of flight crew pressing on with unstabilised approaches. Data from the University of Texas’ line operations safety audit (LOSA) archive identified that only a small number of regularly scheduled flights (five per cent) involved an unstabilised approach. However, alarmingly, only five per cent of these flights resulted in the flight crew conducting a go-around. This means that the vast majority of flight crews knowingly decide to continue with landings that are outside of safe parameters (Merritt & Klinect, 2006).

Of the 120 excursion accidents analysed from the Ascend WAAS database, at least 16 involved a failure by the flight crew to divert or go around following unsafe landing conditions or an unstabilised approach.

Go-arounds are critical to ensuring that unstabilised approaches do not result in unsafe landings, and possibly a runway excursion. National aviation safety regulators such as the French Direction de l’Aviation Civile (DGAC) have emphasised the importance of go-arounds in preventing runway excursion accidents, and have promoted the introduction of standard calls at the minimum

stabilisation height to confirm that the approach is stabilised and a go-around is not required (Werfelman, 2008).

McKinney (2006) claims it is important that operators have a positive 'no-fault' go-around policy, incorporating measures to shift flight crew attitudes from 'go' minded to 'go-around' minded. A way that operators could audit this change is to monitor flight crew compliance with procedures for unstabilised approaches and go-arounds through flight data monitoring, check flights and simulator training

A change in flight crew thinking on go-arounds will help to prevent the re-occurrence of runway excursion accidents that probably would not have occurred if a go-around was conducted. One such accident occurred on 5 March 2000, involving a Boeing 737-300 aircraft at Burbank-Glendale-Pasadena Airport in California. In this accident, the aircraft overran the runway onto a suburban street following an unstabilised approach, coming to rest a few metres from a petrol station. In this instance, the captain did not execute a go-around following the unstabilised approach, which was a breach of operator SOPs. The failure of the flight crew to execute a go-around resulted in a landing at 182 kts (well above the V_{ref} speed of 138 kts), and the aircraft being unable to stop within the remaining runway length (Air Safety Week, 2002).

Case study: Boeing 737-400 runway overrun, Yogyakarta

The fatal runway overrun accident of a Boeing 737-400 at Yogyakarta, Indonesia on 7 March 2007 highlighted how a combination of flight crew techniques and decisions, such as CRM practices and a decision by the flight crew not to execute a go-around when the aircraft approach was unstabilised, can lead to a runway excursion accident.

Figure 16: Boeing 737-400 overrun accident, Adisucipto Airport, Yogyakarta, Indonesia, 7 March 2007



Source: NTSC, 2007

What happened?

Following an unstabilised ILS approach, the Boeing 737-400 aircraft overran the departure end of runway 09 at 110 kts. The aircraft crossed a road and impacted an embankment before stopping in a rice paddy 252 m (827 ft) from the end of the threshold. The aircraft was destroyed by the impact forces and a post-impact fire. Of the 140 crew and passengers on board, there were 119 survivors. One flight attendant and 20 passengers were fatally injured. One flight attendant and 11 passengers were seriously injured.

How did it happen?

The aircraft was flown at an excessive airspeed and steep flight path angle during the approach and landing, resulting in an unstabilised approach. The captain continued the approach, despite company procedures and calls from the first officer requiring a go-around (Lacagnina, 2008b).

Why did it happen?

The Indonesian National Transportation Safety Committee (NTSC) final investigation report identified a number of areas that contributed to the accident.

- Communication and coordination between the flight crew complied with the airline's SOPs, until the aircraft passed through 2,336 ft in the descent after flap 1 degree was selected. At this point, communication between the captain and first officer became less than effective, and compromised the safety of the flight.
- From this point in the descent, the captain flew an unstabilised approach, resulting in a very steep glide path and a very high approach speed (254 kts) compared with the reference approach speed (V_{ref}) of 150 kts.
- The captain did not respond to aural warnings from the ground proximity warning system (GPWS) and from the first officer to go around.
- The operator's Pilot Proficiency Check records showed no evidence of simulator training in appropriate vital actions and responses required to retrieve a perceived or real situation that might compromise the safe operation of the aircraft, including GPWS and enhanced ground proximity warning system (EGPWS) alerts and warnings.
- The less than adequate communication between the captain and the first officer resulted in the first officer not taking control of the aircraft from the captain and executing a go-around, as per the operator's SOP requirement.
- The failure to go around occurred despite the operator having a 'no-blame' policy in place for go-arounds following unstabilised approaches.
- The most recent safety surveillance of the airline conducted by the regulator was four years prior to the accident. The regulator did not have a mechanism in place for ensuring the continued safety standard of the airline's flight operations. The deficiencies in the airline's training and checking procedures went unnoticed by the regulator (NTSC, 2007).

5

CREW PERFORMANCE-RELATED FACTORS IN RUNWAY EXCURSION ACCIDENTS

Flight crew performance factors account for 13 per cent of all factors that were identified as contributing to the 120 runway excursions between 1998 and 2007 identified in the Ascend World Aircraft Accident Summary (WAAS), (Ascend, 2007).

Figure 17 presents a breakdown of how frequently each type of performance-related factors was involved in the 29 runway excursion accidents (24 per cent) where these types of contributing factors were identified. The five most common performance-related issues were:

- flight crew awareness, training and compliance with standard operating procedures (SOPs) for approaches and landings;
- awareness of unserviceable items listed on the minimum equipment list (MEL), and an assessment of their probable effect on the aircraft's braking performance after touchdown;
- standard operating procedures that provided incorrect, ineffective, or no guidance on how flight crew should approach landings in a range of approach and runway conditions;
- degraded situational awareness, due to stress and task saturation; and
- not conducting an accurate calculation of the required rollout length for the aircraft, taking into consideration the runway conditions and approach type.

Figure 17: Breakdown of performance-related factors across 29 runway excursions on landing, 1998 to 2007

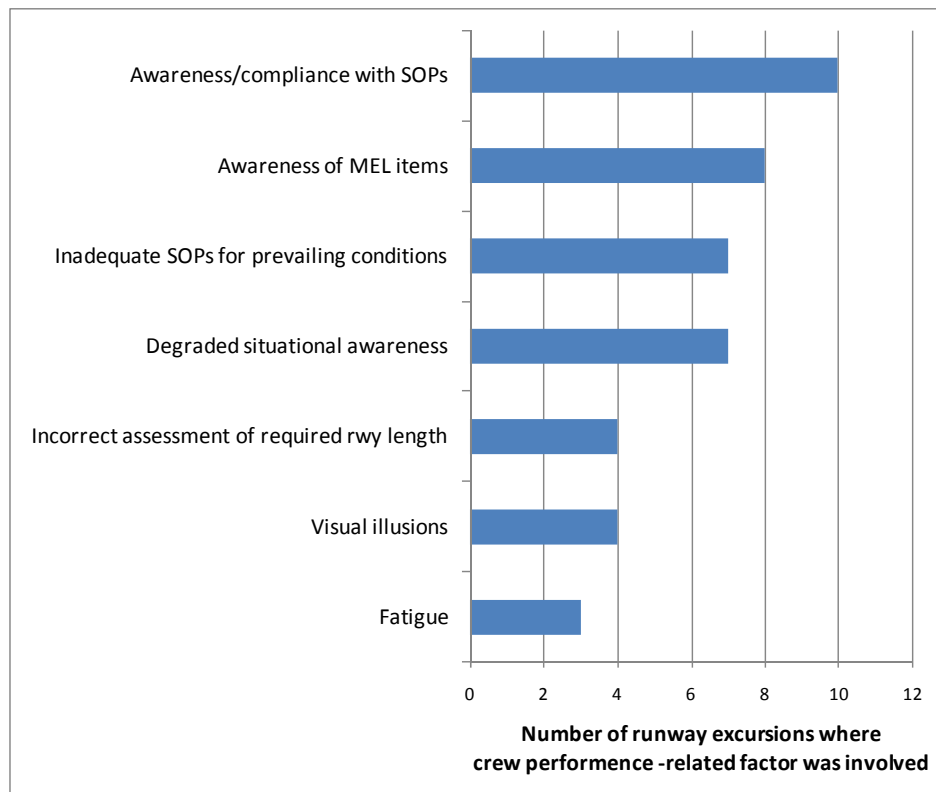

Visual illusions and fatigue were also identified as performance-related factors that could contribute to a runway excursion accident.

This chapter discusses each of these performance-related errors, and how they can increase the risk of an overrun or veer-off occurring. The role of less than adequate SOPs in runway excursion accidents, particularly those related to operations from water-affected and contaminated runways, are discussed in Section 6.3.

5.1 Awareness/compliance with SOPs and MELs

As discussed in Chapter 4, unstable approaches, long and fast landings, and delayed and incorrect flight crew actions are commonly involved in runway excursion accidents. Inadequate awareness of, or flight crew deviations from, SOPs are often the source of these flight crew errors.

In countries such as Australia where wet conditions are infrequent, flight crews are less familiar with landing on water-affected runways. As a result, pilot skills and training for wet weather operations may not match those of pilots in other continents.

Less than adequate flight crew awareness of the MEL and its operational impact have led to incorrect flight crew actions, particularly in regards to thrust reverser-related overruns. In eight of the 120 excursion accidents studied between 1998 and 2007, the flight crew selected full reverse thrust on landing despite an inoperative thrust reverser being noted on the MEL. The result of these actions was asymmetric thrust during the landing rollout, generally leading to a veer-off.

In other cases, incorrect dispatch deviation guides following aircraft maintenance have led flight crews to be unaware of inoperative items until they were needed, potentially placing the aircraft in an unsafe situation.

One accident where procedural and systems awareness were contributing factors involved an Airbus A320 operating in Bacolod, Philippines on 22 March 1998. In that accident, the crew were not aware of items on the MEL that led to unexpected braking action on the runway. Asymmetric thrust caused the aircraft to veer off the side of the runway, overrun and collide with nearby houses.

Case study: Airbus A320 veer-off and overrun, Philippines

What happened?

On 22 March 1998, following a very high frequency omni-directional radio range (VOR) approach to Bacolod Airport, Philippines, an Airbus A320 aircraft landed long, touching down about halfway along the runway. After touchdown, the aircraft veered to the right and ran off the side of the runway. It then continued roughly parallel to the runway until about 100 m (329 ft) before the end when it returned to the runway. The aircraft overran the end of the runway, went through the airport perimeter fence, across a small river and eventually came to rest among houses some 200 m (656 ft) beyond the runway end.

While there were no on-board fatalities associated with this accident, there were three people on the ground who sustained fatal injuries. The aircraft was damaged beyond economical repair.

Figure 18: Airbus A320-200 overrun accident, Bacolod Airport, Philippines, 22 March 1998



Source: Aviation Safety Network, 2008

How did it happen?

The aircraft had been dispatched with the number 1 engine thrust reverser inoperative in accordance with the MEL. The approach was manually flown by the captain with the autothrust engaged in 'speed' mode. During the final stage of the approach, just before touchdown, the callout 'Retard' was repeated five times. At about this time, the number 2 engine thrust lever moved to 'idle' but the number 1 engine thrust lever remained in the 'climb' position. Reverse thrust was selected on the number 2 engine but the number 1 engine remained at high forward thrust. Directional control was lost and the aircraft veered off the side of the runway.

Why did it happen?

The Philippines Civil Aeronautics Board investigation determined that the probable cause of this accident was the 'inability of the captain to assess properly the situational condition of the aircraft immediately upon touchdown with number 1 engine reverse inoperative, thereby causing an adverse flight condition of extreme differential power application during the landing roll resulting in a runway excursion. Contributory to this accident was the apparent lack of technical systems knowledge and lack of appreciation of the disastrous effects of misinterpreting provisions and requirements of a MEL'.

Source: Ascend, 2007; Philippines Civil Aeronautics Board, 2000

5.2 Inadequate SOPs

In many runway excursion accident investigations, a lack of adequate approach and landing SOPs for a range of prevailing weather and runway conditions has been identified as the source of the flight crew errors. Following the runway overrun of an Australian-registered Boeing 747-400 at Bangkok International Airport in 1999, the Australian Transport Safety Bureau (ATSB) found that at the time the operator's SOPs for flap and reverse thrust settings on landing ('flaps 25/idle reverse thrust') were not adequate for water-affected runways (ATSB, 2001).

A stabilised approach SOP is vital for reducing the risk of a runway excursion on landing. Similarly, it is important that SOPs provide a clear guide to pilots about when and how to activate and use of deceleration systems on aircraft (FAA, 2007).

Across the world, many operator SOPs for the landing approach speed (V_{ref}) in crosswind or tailwind conditions, are less than adequate. A Federal Aviation Administration (FAA) Landing Performance Team survey of operator's flight operations manuals and general operating manuals found that approximately half of the operators 'did not have adequate policies in place for assessing whether sufficient landing distance exists at the time of arrival at the destination airport' (FAA, 2007, p. 7).

The calculation of actual versus available landing rollout length prior to landing is another area where some operator SOPs provide little or no guidance. It is important for flight crews to assess the available landing distance as they near their destination airport, as weather conditions are dynamic and can change quickly. Reassessing the landing length also allows for changes in the aircraft weight (due to fuel burn en route) or configuration to be factored in (FAA, 2007).

Major overrun accidents such as that of the Airbus A340 accident at Toronto in 2005, may possibly have been prevented by the reassessment of the actual required landing distance based on conditions at the time of arrival. In the event where this assessment showed that the required runway length was less than the available length, adequate time would normally exist for the flight crew to execute an alternate plan of action such as a go-around, or diversion to an alternate airport if required (TSB, 2007).

5.3 Stress, fatigue and task saturation

Stress, fatigue, task saturation and performance are all closely related, and feed into each other to reduce the flight crew's ability in the critical phases of flight, such as the approach and landing. In these flight phases, the flight crew are required to complete a significant number of complex tasks while maintaining a high level of awareness of the surrounding environment and other air traffic. While a moderate workload or stress level is important for most people to perform well, high workload situations can be detrimental to mental awareness. In high workload situations, these tasks may increase individual stress to a high enough point where the flight crew's ability to complete these tasks accurately is reduced due to the limitations of multiple-task performance. Stressors such as fatigue, frustration, heat and noise may also add to degradation in the performance of the flight crew to complete tasks.

Case study: MD-82 overrun accident, Little Rock

On 1 June 1999, a McDonnell Douglas MD-82 overran the runway after landing at Little Rock National Airport, Arkansas. In this accident, task saturation during a late evening approach in severe weather conditions led to a high flight crew workload. Situational stress contributed to the flight crew losing awareness of approach stability (not realising how much runway was being used up by the flare and initial float) and led to delayed crew action in braking after touchdown (e.g. late thrust reverser deployment, ground spoilers not armed). The effects of situational stress allowed the flight crew to place the aircraft in an undesired state in what were already critical weather conditions. The result was a runway overrun.

Figure 19: McDonnell Douglas MD-82 overrun accident, Little Rock National Airport, Arkansas, 1 June 1999



Source: NTSB, 2001

What happened?

Following an instrument landing system (ILS) approach to runway 04R, the MD-82 touched down about 610 m (2,000 ft) after the threshold. The aircraft failed to stop before the end of the runway and overran. It continued down an embankment, and struck a group of heavy steel stanchions supporting the approach lights for runway 22L. The aircraft came to rest, broken into several pieces, some 150 m (490 ft) beyond the end of the runway. A fire broke out in the rear of the aircraft, gutting the aft cabin. Of the 145 passengers and crew on board, 11 were fatally injured (NTSB, 2001).

How did it happen?

Runway 04R at Little Rock was 2,195 m (7,200 ft) long and was grooved. The accident occurred at night (2350 hrs local time), and there were level 5 (intense) and 6 (extreme) thunderstorms affecting the airport at the time. The runway was wet, visibility was less than 1 NM, and both crosswinds and wind shear were experienced during the approach.

During the landing roll, the aircraft's ground spoilers failed to deploy, and the flight crew found it difficult to maintain control while using reverse thrust. Without the spoilers, it was not possible to stop the aircraft in the runway length available, and it overran the end of the runway at a speed of just under 100 kts (Ascend, 2007).

Why did it happen?

The NTSB determined that the probable causes of this accident were:

- press-on-itis – the captain was committed to landing the aircraft as quickly as possible, despite reports of wind shear, severe thunderstorms, poor visibility, and crosswinds that exceeded limits. The flight crew believed that they could reach the airport before the thunderstorms arrived;
- fatigue – the flight crew had been awake for a continuous period of at least 16 hours, including 13 hours on duty. Their fatigue was aggravated by weather and equipment delays;
- situational stress – research has indicated that stress can degrade an individual's decision-making performance and consequently, ability to assess the current situation and need for an alternative course of action. Despite numerous cues during the approach indicating weather at the airport had deteriorated, the flight crew continued with their original plan to land the aircraft instead of conducting a go-around, entering a holding pattern, or diverting to an alternate airport;
- task saturation – in addition to the challenges faced by the flight crew due to the severe weather conditions, local thunderstorms caused air traffic control (ATC) to change the approach route to runway 04R no less than three times. This increased the workload of the flight crew;
- distractions – caused by lightning, heavy thunderstorms, calls of wind shear with wind reports given at three locations on the airport;
- inability to correctly hear wind readouts from ATC and other aircraft;
- ground spoilers failed to deploy automatically after touchdown, and were not monitored by the flight crew; and
- less than adequate flight crew training in aircraft landing performance on wet and contaminated runways, with strong cross and tail winds (McKinney, 2006; NTSB, 2001).

5.4 Visual illusions and other human factor considerations

Every approach and landing relies on a pilot's skills and experience to ensure that it is conducted successfully. Aircraft frequently operate into airports with varying degrees of infrastructure, ranging from those that are equipped with ground-based instrument approach systems that provide flight crews with precision guidance to a runway, to those with none. Coupled with onboard guidance systems, the flight crew has a range of resources available to assist with an approach and landing.

However, as these resources are diminished, certain human factor considerations may become more pertinent. For example, at airports where approach guidance systems are not available, there is a greater reliance on the flight crew's skills to ensure a stabilised approach. Consequently, the flight crew may be more susceptible to a range of visual illusions associated with the environment surrounding the airport, and the characteristics of the runway itself.

A visual illusion occurs when the pilot's visual perception of the environment differs from his or her expectations. Such illusions, some of which are described

below, may result in spatial disorientation or approach and landing errors, such as a long or short landing.

The FSF ALAR Task Force found that flight crew visual illusions were a contributing factor in 21 per cent of approach and landing accidents and serious incidents (FSF, 2000a).

Of the 29 runway excursion accidents on landing between 1998 and 2007 that involved performance-related factors identified in the Ascend WAAS data, visual illusions or an incorrect assessment by the flight crew of the required landing rollout length, were contributing factors in eight accidents.

Flight crews are particularly susceptible to visual illusions in poor visibility or at night, as there are few visual cues available during the approach. The FSF estimates from ALA data that the approach and landing accident rate is three times higher at night than during the day (Khatwa & Helmreich, 1999).

Visual illusions can occur because of a number of airport, runway and weather factors.

5.4.1 Airport environment illusions

Features of the environment around the airport may create visual illusions and cause the flight crew to inadvertently place the aircraft into an unstabilised approach. This increases the risk of a long and/or fast landing, and a runway excursion (FSF, 2000a).

- ‘Black hole’ effect along the final approach path due to sparse ground lighting at night, creating the illusion of being too high and leading to a low approach.
- Uphill-sloping terrain along the final approach path creating the illusion of being too high. As a result, the flight crew may descend the aircraft to what they perceive to be the correct approach path, placing the aircraft below the desired approach path (Figure 20, top).
- Downhill-sloping terrain along the final approach path, creating the illusion of being too low. Conversely to uphill-sloping terrain, the flight crew may climb the aircraft, leading to a high approach (Figure 20, bottom).

Figure 20: Visual effects caused by different approach path terrain slopes

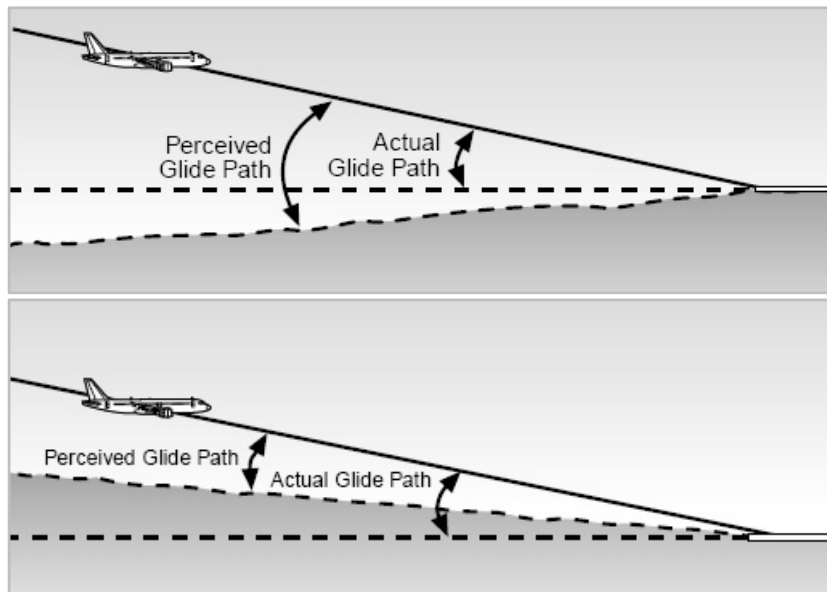

Source: FSF, 2000a

5.4.2 Runway illusions

Runway dimensions and slope produce similar visual effects to those of the terrain surrounding the airport. The aspect ratio²⁴ of the runway in particular affects how it is visually perceived by the flight crew (FSF, 2000a).

- A high aspect ratio runway (narrow or long) creates the impression of being too high, which can lead to a correction by the flight crew that results in an unstabilised approach that is too low. This increases the risk of undershooting the runway if the approach is not corrected (Figure 21, left).
- A low aspect ratio runway (wide or short) creates the impression of being too low, which can lead to a correction by the flight crew that results in a high unstabilised approach. An extended flare and long landing can occur if the approach is not corrected (Figure 21, right).

²⁴ The aspect ratio of a runway is the ratio of the runway length to the runway width. A high aspect ratio runway is long and narrow, where a low aspect ratio runway is short and wide.

Figure 21: Visual effects caused by different runway aspect ratios

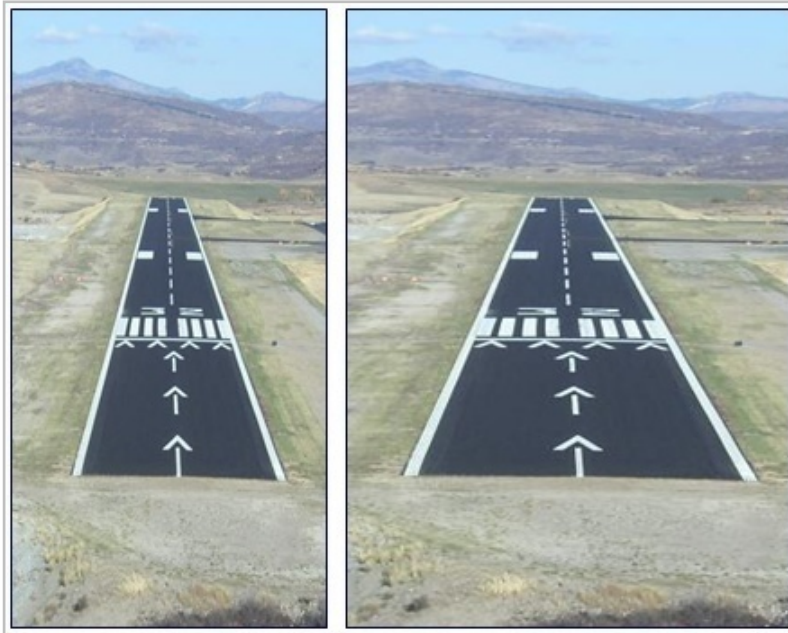

Source: Ayres, 2007

Uphill and downhill-sloping runways create the same perception problems for flight crews as sloping terrain under the final approach path, and may result in the aircraft being placed in an unstabilised approach that is too low or too high.

The slope or gradient of a runway also has an effect on the landing rollout distance. Where the destination runway has a downward slope of two per cent or more, it is generally indicated in the operator's SOPs, and can be accounted for in landing performance computations prior to touchdown. However, smaller slopes are usually not accounted for in SOPs or displayed in aerodrome charts/runway data. Even a one per cent downhill slope in the runway surface can increase landing distance by 10 per cent (FAA, 2007).

Inadequate or non-standard runway lighting can also be a safety factor in veer-offs. This is especially true on wide runways or airports where a 'black hole' effect exists along the approach path, as pilots can experience visual illusions. This may lead to an incorrect glide path being flown, and a landing outside of the touchdown zone.

In the Boeing 737-300 veer-off serious incident that occurred at Darwin International Airport in 2003, the ATSB investigation found that the non-standard runway lighting and an unusually wide runway were contributing factors to pilot disorientation. This led to the aircraft touching down towards the runway edge; veering off and striking several runway edge lights (see Section 3.4).

5.4.3 Weather illusions

In the FSF ALAR Task Force study of ALA causes, poor visibility was found to exist in almost 60 per cent of approach and landing accidents. Visibility and poor weather conditions can create visual illusions that have been known to contribute to unstabilised approaches, and long/fast landings (FSF, 2000a).

Crosswinds

The required position of an aircraft when landing in a crosswind will cause the runway to appear to the pilots to be at an angle to the aircraft heading. This may lead the flight crew to align the aircraft with the runway centreline, causing the aircraft to drift off-track and create an unstabilised approach. This phenomenon is particularly associated with runway veer-offs.

Two accidents were identified where visual illusions associated with crosswinds were found to have partially contributed:

- a Canadair RJ 100 veer-off at Fredericton Airport, New Brunswick, Canada on 16 December 1997; and
- a McDonnell Douglas DC-9-41 veer-off at Turku Airport, Finland on 30 December 1997.

In the Canadian accident, the aircraft touched down in snow conditions at night with a crosswind, and veered off the right side of the runway as the crew attempted to conduct a go-around. After veering off the runway, the aircraft struck a snow drift, followed by a ditch, a sand hill and a stand of trees. One tree tore a hole in the aircraft cabin. While there were no fatal injuries, nine of the 42 passengers and crew were seriously injured.

An investigation by the Canadian Transport Safety Board (TSB) established that the first officer flew a crabbed approach to compensate for the right crosswind, however, on the final approach, the crosswind reduced from 10 kts to calm. When the first officer applied left rudder and aileron to align the aircraft with the runway, he did not perceive the resulting left bank. Although right rudder was applied as the aircraft crossed the centreline of the runway, this did not counter the aerodynamic effect of the left bank, and the aircraft continued to drift away from the runway centreline to the left side of the runway.

The investigation also determined that a lack of runway centreline and touchdown zone lighting contributed to the first officer not being able to see the runway environment clearly enough for him to maintain the aircraft on the approach path and the runway centreline (TSB, 1997).

In the Finnish accident, the aircraft touched down to the right of the centreline in blowing snow, at night, and with an 8 kt crosswind component from the left. The aircraft veered off the right side of the runway, travelling for approximately 550 m before returning to the runway surface. There were no injuries to the aircraft occupants, and the aircraft suffered only slight damage.

An investigation by the Finnish Accident Investigation Board (Onnettomuustutkintakeskus) established that the captain disconnected the autopilot at an altitude of about 100 ft (30 m), shortly before crossing the runway threshold. The crosswind caused large snowflakes to drift from left to right in the pilot's field of view, giving the captain an impression that the aircraft was left of the centreline. To compensate for the perceived aircraft position, the captain decreased the approach crab angle, and placed the aircraft into a slight left bank to align the aircraft with the runway. The aircraft touched down with the left main wheels 13 m to the right of the runway centreline, and with the right main wheels 12 m inside the right edge line of the runway. The aircraft veered off the right edge of the runway three seconds after touchdown. The captain reported that he did not perceive that

the aircraft was running off the side of the runway until it impacted the runway edge lights.

The investigation also determined that there were no runway centreline lights installed, and that the snow cover on the runway surface was reported to be so thick that runway markings were not visible (Onnetomuustutkintakeskus, 1997).

Haze and fog

Haze, smoke, fog and dust can obscure the runway surface during final approach, and tend to result in the flight crew perceiving that the aircraft is too high on approach. Haze creates the impression that the runway is farther away than it is, and can result in a tendency to fly a shallow glide path and land long.

When the aircraft is above shallow fog layers (less than 300 ft in thickness), the airport and runway can be seen, however, when the aircraft enters the fog layer, the flight crew lose forward and slant visibility. Flying in fog layers also creates a perception that the aircraft is pitching up, resulting in a nose-down correction by pilots, and a steepening of the approach path. Such actions by flight crew on final approach have led to controlled flight into terrain accidents where the margin for perception error is small.

An example where the presence of fog on final approach has contributed to a runway excursion accident involved an Airbus A319 aircraft at Winnipeg International Airport, Manitoba, Canada on 26 December 2005. In this incident, the aircraft was flying a stabilised approach until just prior to touchdown, at which point the flight crew's visual contact with the runway was obscured by shallow fog layers over the runway surface and the reflection of the aircraft's landing lights off the fog. While the captain believed he was still over the runway centreline, the fog obscured visual cues and he could not detect that the aircraft was drifting to the left due to a prevailing crosswind. At a height of 30 ft, the first officer observed that the aircraft was drifting to the left, which was acknowledged by the captain. The captain proceeded to crab the aircraft to correct the drift, at which point the aircraft touched down on the left edge of the runway. While no occupants sustained injuries and there was no major damage to the aircraft, it did strike two runway lights causing a cut in one of the left main wheel tyres (TSB, 2006).

Heavy rain

Heavy rain affects depth and distance perception, and can result in approaches that are too low or too high. For example, in a high approach:

- heavy rain makes the approach lighting system appear dimmer during daylight conditions, making the runway appear further away than it is. This causes a tendency to fly a shallower glide path and land long; and
- wet runways reflect little light, making the runway appear further away than it is. This can result in a late flare and a long or hard landing.

Severe weather conditions may compound high stress and workload, and lead to the pilots becoming task saturated. An example of an accident where this was a significant contributing factor was the overrun of an Airbus A340-300 aircraft at Lester B. Pearson International Airport, Toronto, Canada on 2 August 2005.

Case study: Airbus A340-300 overrun accident, Toronto

What happened?

On 2 August 2005, following an instrument landing system (ILS) approach to runway 24L at Lester B. Pearson International Airport, Toronto, Canada, an Airbus A340-300 aircraft landed long and then overran the runway, falling into Etobicoke Creek some 200 m beyond the end of the runway. A fire broke out and the aircraft was destroyed. The accident happened in daylight, but in severe weather conditions. All aircraft occupants were able to evacuate the aircraft before the post-impact fire reached the escape routes, with two flight crew and 10 passengers sustaining serious injuries. No aircraft occupants were fatally injured.

Figure 22: Airbus A340-300 overrun accident, Lester B. Pearson International Airport, Toronto, Ontario, Canada, 2 August 2005



Source: TSB, 2007

How did it happen?

The aircraft was flying a stabilised approach until the decision height of 200 ft. At this point, the flight crew disconnected the autopilot and autothrust in preparation for the landing. However, during the flare, the aircraft travelled through an area of heavy rain, and visual contact with the runway environment was significantly reduced. There were numerous lightning strikes occurring, particularly at the far end of the runway. The aircraft started to increase in speed and deviate above the glideslope, causing the aircraft to float above the runway and land long.

Runway 24L was 9,000 ft (2,744 m) in length. The aircraft touched down about 3,800 ft (1,160 m) beyond the runway threshold. As the aircraft crossed the runway threshold, with the heavy rain, low visibility, lightning and variable winds, the flight crew became overwhelmed by the severe weather conditions and became task saturated, making a normal landing difficult. Because the flight crew were focused on maintaining visual contact with the runway, they did not notice that the wind had shifted from a headwind to a 10 kt tailwind during the flare, significantly increasing the landing distance in the prevailing weather conditions.

Due to task saturation on the flight deck, the first officer did not make the standard calls confirming the deployment of the spoilers and thrust reversers following the touchdown. As a result, reverse thrust was not deployed until about 12.8 seconds after landing, and full reverse was not selected for more than 16 seconds after touchdown. The wet runway also reduced the effectiveness of pedal braking. The aircraft was not able to stop before the end of the runway, and overran at a ground speed of about 80 kts.

Why did it happen?

At about the point where the aircraft crossed the runway threshold, it entered the perimeter of a thunderstorm cell. An investigation by the TSB determined that a number of factors coalesced from this point to place the aircraft in an unsafe situation, including:

- The intense rain and lightning during the approach made visual contact with the runway very difficult.
- After the autopilot and autothrust systems were disengaged, the pilot flying increased the thrust in reaction a perception that the aircraft was sinking. The power increase allowed the aircraft to deviate above the glide path.
- The change in the wind direction from a headwind to tailwind increased the landing length of the aircraft, and was not perceived by the flight crew in their task saturated state. This also contributed to the aircraft crossing the runway threshold at 40 ft above the normal threshold crossing height.
- When the aircraft reached the threshold, it entered an intense downpour, severely reducing the forward visibility of the flight crew and making it difficult to determine the position of the runway touchdown zone.
- The flight crew experienced cognitive narrowing as they became focused on using the side windows to determine the lateral and vertical position of the aircraft. This also contributed to the delay in applying reverse thrust following touchdown (TSB, 2007).

WEATHER-RELATED FACTORS IN RUNWAY EXCURSION ACCIDENTS

Weather-related factors account for 37 per cent of all factors identified that contributed to the runway excursions between 1998 and 2007 in the Ascend World Aircraft Accident Summary (WAAS), (Ascend, 2007). Of the 120 runway excursions on landing, 81 (68 per cent) involved at least one potentially unsafe weather factor that contributed to the accident.

More specifically, wet or contaminated runways were present in 77 (64 per cent) of the 120 runway excursion accidents. Marginally more accidents involving wet or contaminated runways were overruns than veer-offs (62 per cent). However, weather-related factors did not result in any of the runway excursions without the presence of other contributing factors. Typically, these were factors such as unstabilised approaches, long and/or fast landings, selecting a runway that was not suitable for the aircraft type, approach type or prevailing conditions, failing to go-around where potentially dangerous conditions existed, or delayed or incorrect use of braking devices. Such factors can be compounded by poor environmental conditions and increase the risk of unsafe outcomes, such as a runway excursion.

Figure 23 presents a breakdown of how frequently different types of weather-related factors were involved in the 81 runway excursion accidents. The three most common weather-related issues were:

- a wet or water-affected runway that reduces the friction between the aircraft tyres and the ground, leading to degraded directional control during the landing rollout and lower pedal braking effectiveness;
- landing in a crosswind above the limits published in the standard operating procedures (SOPs) or the manufacturer's aircraft flight manual (AFM); and
- landing in a tailwind above the published limits.

In some cases, potentially unsafe weather conditions are obvious to the flight crew (e.g. thunderstorms in the airport vicinity, runway condition briefings from other aircraft), and the appropriate actions can be taken to avoid them. Some runway accidents occur when the flight crew is aware of poor weather at the destination airport, but continue with a landing. This may be due to less than adequate SOPs for landing in potentially unsafe weather conditions, factors such as press-on-itis and flight crew fatigue, or overconfidence.

However, unsafe runway conditions are sometimes not apparent until after touchdown, at which point the aircraft is in an unsafe state (such as aquaplaning) and the flight crew cannot stop or control the aircraft on the runway.

In all cases, poor runway conditions increase the required landing rollout length, making it more difficult for the flight crew to stop the aircraft within the remaining runway length available.

This chapter will discuss the effect of tailwinds, crosswinds, and other environmental and runway condition factors on rollout length.

Figure 23: Breakdown of weather-related factors across 29 runway excursions on landing, 1998 to 2007

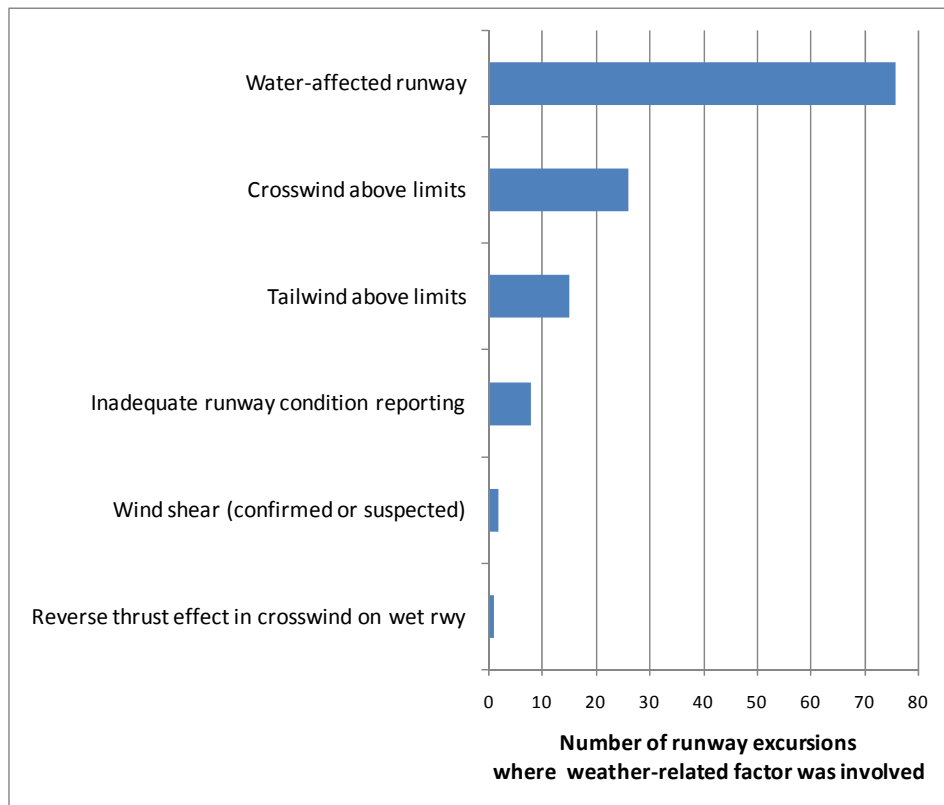

Case study: Airbus A320-200 overrun, Sao Paulo

If environmental factors (such as a wet runway or crosswind) are combined with a long or fast landing, the margin between required and available runway length becomes critical. In these situations, the risk of an overrun or veer-off greatly increases. The overrun accident of an Airbus A320 at Congonhas (Sao Paulo) Airport in Brazil on 17 July 2007, showed how a range of crew technique, decision, weather and systems factors can combine to result in a tragedy.

What happened?

The tower controller cleared the Airbus A320 to land on runway 35L at Congonhas Airport, Sao Paulo after operating a flight from Porto Alegre, Brazil. The aircraft was destroyed when it overran on landing. After departing the end of the runway, the aircraft veered slightly to the left before going over a steep embankment. It became airborne as the ground fell away beneath it, flew over a major road, and impacted a TAM Express cargo building on the far side of the road at a speed of 94 kts. A fire broke out that destroyed both the aircraft and the building. All 187 crew and passengers on board and 12 people on the ground were fatally injured.

Figure 24: Airbus A320 overrun accident, Congonhas Airport, Sao Paulo, Brazil, 17 July 2007



Source: USA Today

How did it happen?

At the time of writing, the accident was being investigated by the Brazilian Centro de Investigação e Prevenção de Acidentes Aeronáuticos (CENIPA).

Initial analysis of the flight data recorder and cockpit voice recorder data by the NTSB several days after the accident indicated that the flight crew were aware that the aircraft's right thrust reverser was unserviceable and not available for the landing. The cockpit voice recorder transcript also indicates that the spoilers did not activate after touchdown, delaying the deceleration of the aircraft on the runway.

In the wet conditions, it is possible that the aircraft aquaplaned and hence did not stop before the end of the runway. Flight crew error may have also potentially played a role in the delayed braking of the aircraft

Why did it happen?

The runway conditions at the time of the accident were 'wet and slippery', and the wind was reported from 330 degrees at 8 kts. Runway 35L had an asphalt surface and had recently been resurfaced; however, it was not grooved at the time. The accident happened in darkness (1850 local time). Runway 35L had a published landing distance of 1,879 m at the time of the accident.

At the time of the accident, the aircraft was operating with a deactivated thrust reverser on the number 2 (right) engine.

(Ascend, 2007; Aviation Safety Network, 2008).

6.1 Water-affected and contaminated runways

Wet and contaminated runways are a major contributing factor to runway excursion accidents as they can exacerbate the risk that other factors could result in an overrun or veer-off (such as unstabilised approaches, long and fast landings, and delayed braking actions by flight crew). Pools of standing water or other contaminants on the runway surface present additional risks to the safety of the aircraft during the landing roll, such as aquaplaning.

The European Joint Aviation Authorities (JAA) defined a runway as 'wet' when its surface is covered in water or an equivalent contaminant (such as slush) so that it appears reflective, but without significant areas of standing water present (FSF, 2000f).

What constitutes a contaminated runway varies between different aviation safety regulators. For example, the Federal Aviation Administration defines a runway as 'contaminated' whenever standing water, ice, snow, slush, frost, heavy rubber or other substances are present (FAA, 1978). In comparison, the JAA provides specific standing water depth measurements to determine if a runway is contaminated.

Analysis of the Ascend WAAS data showed that approximately 64 per cent ($n = 77$) of the 120 landing overruns and veer-offs that occurred between 1998 and 2007 involved water-affected and contaminated runways. The FSF ALAR Task Force suggests this figure may actually be higher, at 75 per cent of all runway overruns and veer-offs (Khatwa & Helmreich, 1999).

Effects of runway contamination

The presence of water, snow, slush, ice or a solid contaminant (such as rubber deposits from aircraft tyres) on the runway adversely affects an aircraft's braking performance by (FSF, 2000f):

- reducing the friction force between the tyres and the runway surface; and/or
- creating a layer of standing water between the tyres and the runway. This reduces the contact area and increases the risk of aquaplaning (see Section 7.1).

Standing water can exist as a layer on the runway surface, or form into pools (in potholes, other dips in the runway etc.). Runways that are not cambered to allow water runoff can exacerbate the accumulation of standing water into pools. Crosswinds have a similar effect, as they push draining water back up onto the runway surface.

The accumulation of standing water can also be reduced by runway grooving, which assists drainage during normal rainfall conditions. Most runways worldwide are not grooved. While grooving is effective in normal rainfall conditions, it may not make a significant difference to the stopping distance of an aircraft in severe rainfall conditions. This is due to the sheer volume of water involved in intense weather systems such as tropical and monsoonal storms. During periods of heavy rain, water depth on grooved runways can still be more than 15 mm, resulting in a high risk of aquaplaning (Ranganathan, 2006).

Runway contamination from rubber deposits can also lead to a serious reduction in runway surface friction coefficients²⁵, especially if the runway is wet (TSB, 2007). Rubber deposits are usually heaviest in the runway touchdown zone and on either side of the centreline. The depth of these deposits depends on the number of landings and the period between runway surface cleanings, but can be as much as 8 mm. Rubber deposits act to disperse rain into pools of standing water at varying depths, which can cause aquaplaning or differential braking (Ranganathan, 2006). This can increase the risk of a runway veer-off.

6.2 Tailwinds and crosswinds

Many runway excursion accidents have followed a landing in tailwinds or crosswinds above operational or aircraft design limits. The accident risk of landing on a water-affected runway increases with high crosswinds or tailwinds due to the added groundspeed of the aircraft and the possibility of aquaplaning conditions.

A study of 180 landing overruns involving turbine-powered aircraft found that 50 per cent involved a tailwind. Twenty per cent of all landings involved a tailwind of 5 kts or greater (Kirkland et al, 2004).

In comparison, the present analysis of the 120 runway excursions involving jet aircraft on landing between 1998 and 2007 recorded in the Ascend WAAS showed that tailwinds over 5 kts were present in 26 (22 per cent) of accidents. In 15 of those accidents, the tailwind was identified as a probable contributing factor to the accident.

Crosswinds were present in a slightly larger proportion of the 120 accidents recorded in the WAAS, and existed in 35 (approximately 30 per cent) of all landing excursion accidents. The crosswind conditions were identified as a probable contributing factor in 26 of these accidents.

6.2.1 Tailwinds

Tailwinds increase the approach and touchdown groundspeed of the aircraft, meaning that more runway length is required to decelerate the aircraft. This can be critical where poor runway conditions exist, or where the required runway length for landing is close to the available runway length. The Federal Aviation Regulations (FARs) and Joint Aviation Regulations (JAR) 25.105 and 25.125, require that 150 per cent of the reported tailwind is factored in when calculating the required landing length (van Es & Karwal, 2001).

In most tailwind-related overruns, the critical safety factor was a violation of operator SOPs for landing in windy conditions. A study of 33 tailwind-related overrun events between 1980 and 1999 found that (van Es & Karwal, 2001):

- 91 per cent occurred during landing;

²⁵ The braking action coefficient of friction (Mu) is the ratio of the tangential force needed to maintain uniform relative motion between two contacting surfaces (aircraft tyres to the pavement surface) to the perpendicular force holding them in contact (distributed aircraft weight to the aircraft tyre area). It is used as a simple way to quantify the relative slipperiness of pavement surfaces, such as runways. Mu values range from zero to 100, where zero is the lowest friction value, and 100 is the maximum friction value obtainable.

- the tailwind was higher than 10 kts in 46 per cent of cases, which is above the operator SOP limit for most aircraft;
- the majority (70 per cent) occurred on water-affected or contaminated runways, where braking action was reduced; and
- 12 per cent occurred on contaminated runways – normally operator SOPs do not allow tailwind landings on contaminated runways.

Appendix F lists the manufacturer design tailwind limits (as quoted in the AFM) for a range of Western-built commercial jet aircraft. While some of these aircraft are capable of landing in tailwinds above 10 kts, the FAA and JAA regulations impose an operational limit of 10 kts. Approval of tailwind operations above 10 kts requires specific flight testing under FAA Advisory Circular AC 25-7A *Flight Test Guide for Certification of Transport Category Airplanes* (van Es & Karwal, 2001). Considering the cost versus benefit of conducting such flight testing, most operator SOPs impose a 10 kt tailwind limit on landings.

In addition to water-affected and contaminated runways, unstabilised approaches were also characteristic among overruns where a significant tailwind existed (van Es & Karwal, 2001):

- almost half of tailwind-related overruns (43 per cent) involved unstabilised approaches with an excessive approach speed over the ground;
- long landings were involved in over half (54 per cent) of tailwind-related overruns, due to excessive floating above the runway (i.e. an extended flare); and
- floating above the runway occurred in about two-thirds (67 per cent) of all tailwind-related overruns where the approach speed over the ground was also excessive.

6.2.2 Crosswinds

Crosswinds are a major contributing factor to runway veer-offs. Common factors involved in crosswind-related excursions are flying an incorrect crosswind approach, a crosswind above SOP limits, or a failure to use correct braking techniques for crosswind conditions.

Veer-offs accounted for eight per cent of all approach and landing accidents and serious incidents worldwide between 1984 and 1997, with crosswinds and wet runways involved in the majority of those (FSF, 2000f). Analysis of the 120 runway excursion accidents on landing recorded in the WAAS showed that of the 49 veer-off accidents that occurred between 1998 and 2007, a crosswind was a contributing factor in 18 (37 per cent) cases. A wet, water-affected, or contaminated runway was present in 30 (61 per cent) of the veer-off accidents.

The maximum recommended crosswind for landing reduces if the runway conditions are potentially unsafe. In good runway conditions (i.e. a runway friction coefficient above 0.4), the maximum recommended crosswind can be as high as 35 kts for some aircraft operations. However, poor runway conditions, such as the presence of standing water, can reduce this limit to as low as 5 kts, due to the high risk of aquaplaning (FSF, 2000g). Crosswinds can also push water back onto the runway surface, affecting drainage and creating pools of standing water.

Incorrect crosswind approach techniques can be a factor in veer-offs, as they can lead to an unbalanced approach. Drifting during the transition from a wings-level crosswind approach (crabbed) to a steady-sideslip crosswind approach, or failing to transition from a wings-level approach to a steady-sideslip approach (de-crab) when landing in strong crosswind conditions can increase the risk of runway excursions (Figure 25) (FSF, 2000d).

Figure 25: Crabbed and sideslip (de-crab) approaches in crosswind conditions

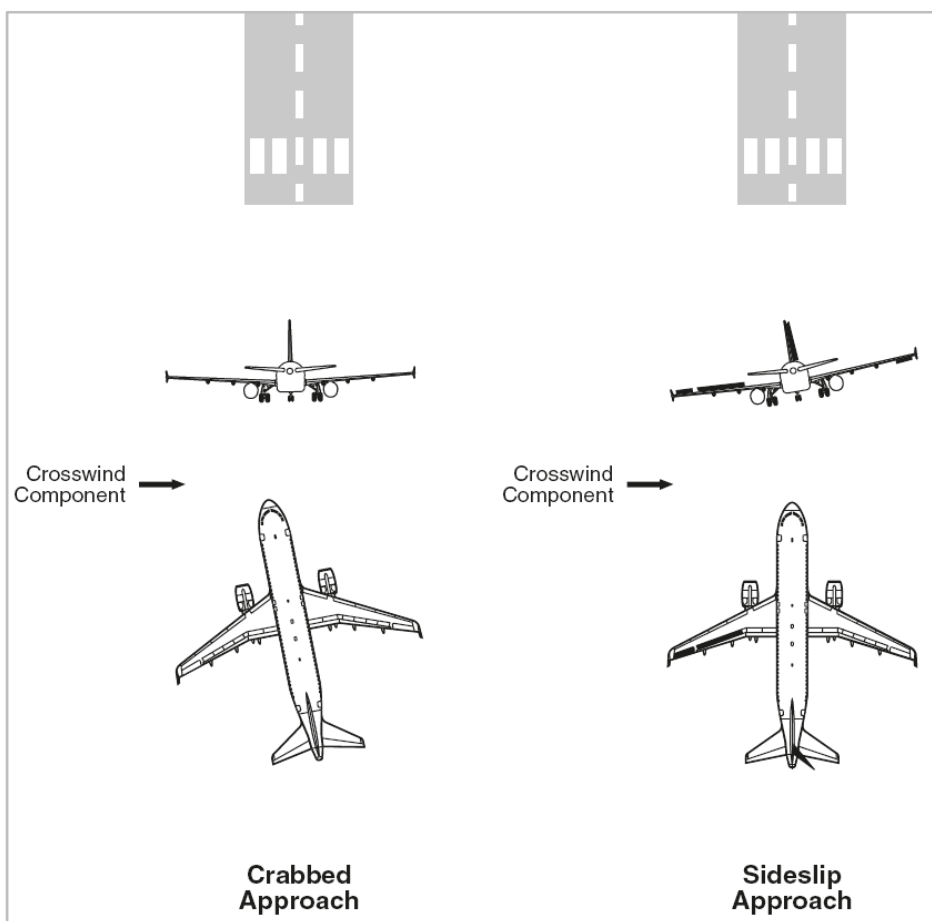

Source: FSF, 2000d

Braking procedures in crosswind conditions are different from normal landings due to the additional force on the lift devices and spoilers on the into-wind wing. The differential force results in a higher wheel loading on that side of the aircraft, which increases brake effectiveness on the into-wind tyres. A reduction in tyre cornering force results, and the aircraft tends to veer into the crosswind (FSF, 2000g). On water-affected runways, the use of braking or nosewheel steering to bring the aircraft back on to the runway centreline can lead to aquaplaning and loss of directional control. The use of reverse thrust when the aircraft is misaligned with the runway centreline can also lead to a loss of directional control.

To safely decelerate the aircraft in a crosswind, a combination of into-wind aileron and opposite rudder should be used in conjunction with differential braking to provide directional control and return the aircraft to the centreline. Reverse thrust and normal braking can then be used to decelerate the aircraft (Figure 26) (TSB, 2007).

Figure 26: Recovery from a skid caused by crosswind and reverse thrust side forces

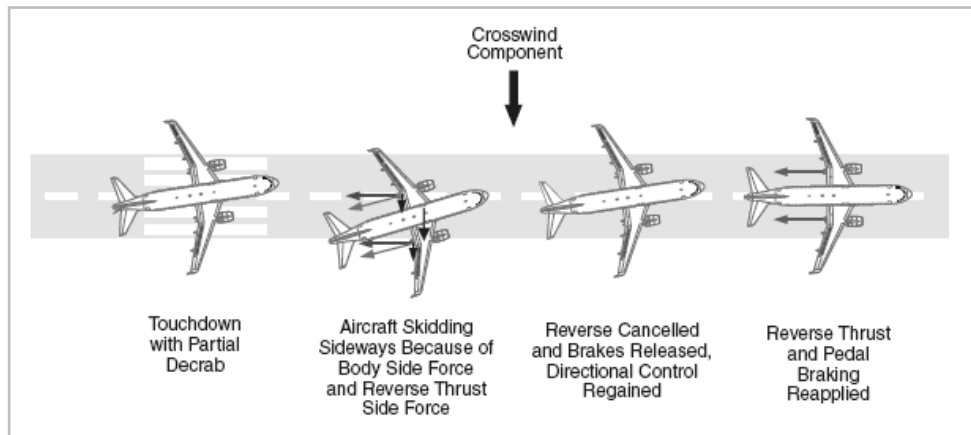

Source: FSF, 2000g

6.3 How much do weather and runway conditions really affect the landing rollout length?

One or a combination of weather-related factors can significantly increase the landing rollout length, and increase the risk of an overrun either as a contributing factor in its own right or by compounding the effects of other crew technique, system and performance-related factors. Crosswinds, tailwinds, water-affected and contaminated runways all contribute to runway accidents. In the case of water-affected or contaminated runways, lower runway friction coefficients in these conditions reduce brake effectiveness. Tailwinds increase the speed of the aircraft, meaning more runway length is required to stop. High crosswinds combined with wet runway conditions increase the risk of aquaplaning and a loss of directional control.

Figure 27 shows how some common flight crew technique and decision-related, flight crew performance-related, systems-related, and weather-related factors, affect typical landing rollout lengths. The effects of ice, snow and high-altitude runways are not specifically discussed in this report as they generally do not apply to Australian air operations; however, Figure 27 provides an indication of the relative impact of those operating conditions on runway rollout length.

If several factors are combined (e.g. a long landing in wet conditions with ground spoilers not armed), the increase in landing distance is cumulative.

Figure 27: Landing distance factors affecting rollout length

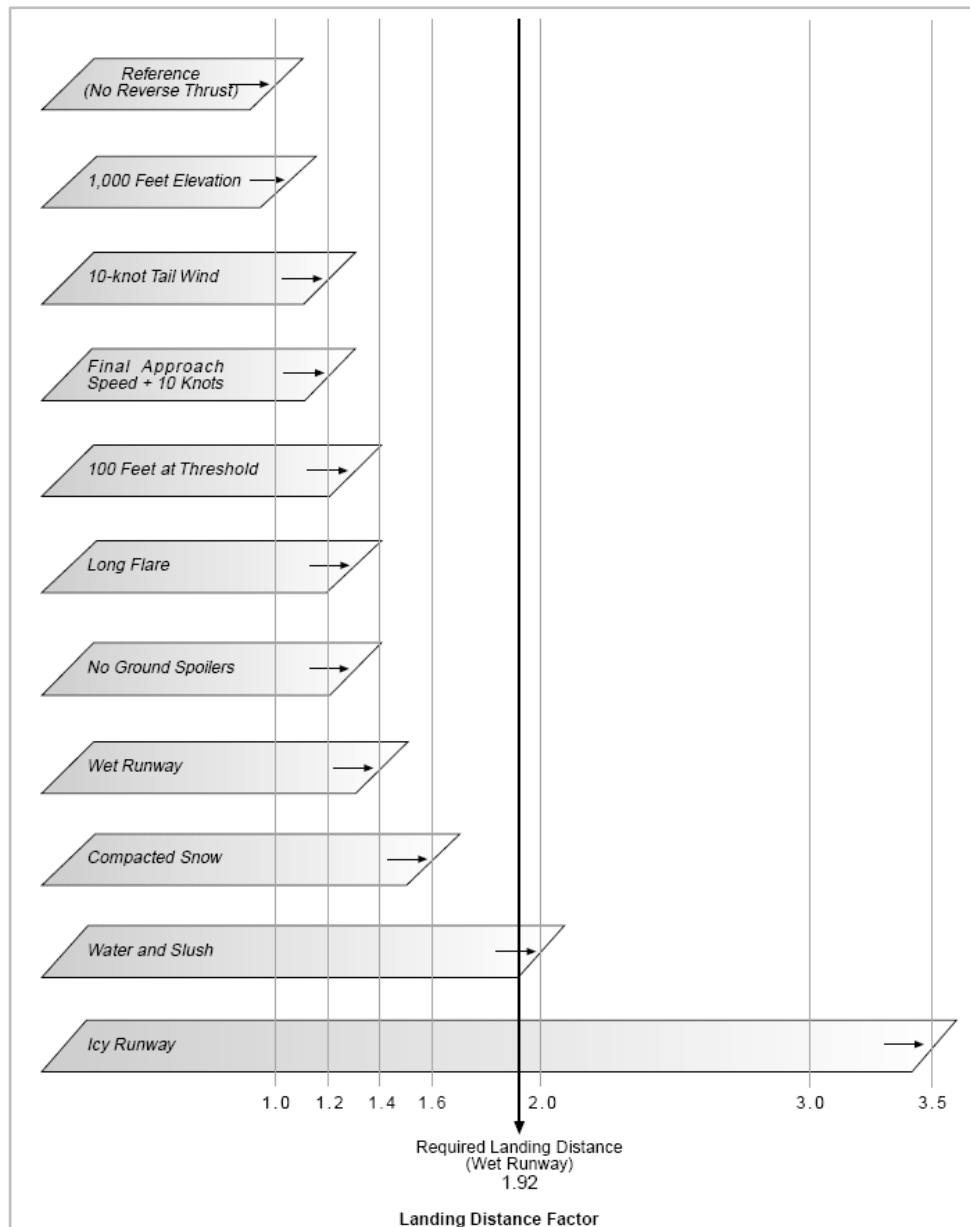

Source: FSF, 2000d

When developing SOPs to calculate required landing distances, it is important for operators and flight crews to be aware that the unfactored landing distances provided in the manufacturer-supplied aircraft flight manual (AFM) reflects landing performance in test conditions as flown by test pilots. The FAA FAR Parts 23.75 and 25.195, require manufacturers to quote these distances in the AFM, and specify the required flight test conditions to evaluate these distances. These landing distances are calculated by test pilots in ideal conditions, and are not representative of normal flight operations. Landing distances on water-affected runways quoted in the AFM are generally extrapolated from landing lengths in dry conditions, rather than performing test landings in actual wet conditions (Ranganathan, 2006). Because of this, the FAA recommends that SOPs and flight crews use either factored landing distances (Figure 27), or add a safety margin to the unfactored

landing distance quoted in the AFM when assessing the required landing length at the time of arrival (FAA, 2007).

As previously discussed, tailwinds increase approach speeds, and increase the runway length required to stop the aircraft. Figure 28 shows how landing in tailwinds above the standard 10 kt limit increases rollout length and the relative effect during normal airspeed approaches compared with fast approaches.

Figure 28: Effect of tailwinds on landing rollout length at different approach speeds

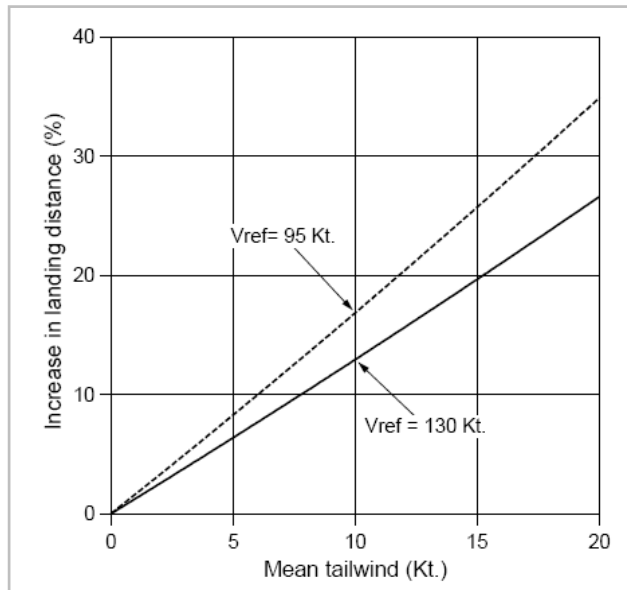

Source: van Es & Karwal, 2001

Stopping in the wet - how much braking force is available?

Case study: The Boeing 787-8 Dreamliner

A lot of force is involved in stopping a landing aircraft. The free body diagram below shows the major forces involved in stopping a jet airliner, such as the Boeing 787 Dreamliner (787).

The 787 will become a familiar sight in Australian skies over the next 20 to 30 years, and represents a typical medium-size commercial jet aircraft.

When the aircraft touches down, the weight of the aircraft is distributed across the nose and main wheels, creating a reaction force with the ground (N). At this point, the aircraft is still travelling at speed, and aerodynamic drag (D) provides most of the deceleration force to slow the aircraft down during the landing roll. Reverse thrust (T_{REV}) is also used for part of the landing rollout to provide further deceleration. At slower ground speeds, rolling drag from the wheels and brakes (μN) is the main stopping force. Lift (L) and aircraft weight (W) effect how much rolling drag is available.

Figure 29: Major aircraft forces during landing

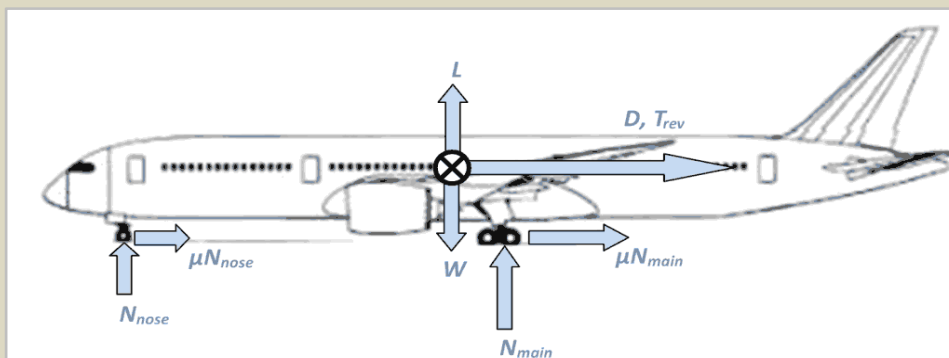

Source: Adapted from Jane's, 2008

Maximising an aircraft's total drag is the only way to reduce the rollout length. On a water-affected or contaminated runway, however, braking effectiveness is much less than normal. This is especially so if reverse thrust is not used, as was the case in several overruns such as the Boeing 747-400 accident in Bangkok in 1999.

If the runway is dry, it has a good friction coefficient of 0.4 or above. If no reverse thrust is used on landing, the 787 has a:

- landing rollout length of approximately 629 m (2,063 ft); and
- available braking force of approximately 613 kN (see Appendix G for calculations).

If the runway is water-affected, however, the μ value drops to approximately 0.2. In these conditions, the 787 has a:

- landing rollout length of approximately 1,411 m (4,629 ft); and
- available braking force available of approximately 109 kN (see Appendix G for calculations).

This is a **225 per cent increase in rollout length in wet conditions**. The reduced friction on the wet runway means that **only 18 per cent of normal braking action is available**. Similar results are achieved with other commercial jet aircraft of similar size and weight (such as the Boeing 767 or Airbus A330). Larger aircraft, such as the Airbus A380, require even more force to stop.

Note: These calculations are based on a late-2005 pre-production baseline for the Boeing 787 and do not represent actual in-service performance (Lissys Piano, 2006). Assumptions, variables, and calculations for these results are provided in Appendix G.

6.3.1 Regulatory standards on runway rollout length

A range of factors (crew technique and decision-related, performance-related, weather-related and systems-related) increase the risk of a runway excursion accident occurring as they generally increase the rollout length required after touchdown to stop the aircraft. For this reason, regulators set minimum requirements for landing lengths. These are often factored into published landing distances for different conditions, and are included in the AFM or operator SOPs for that aircraft type. The primary regulatory requirements for landing distance calculations are listed below.

- **United States and Europe** - FAA Part 121.195 and JAA JAR-OPS-1 require that the total available runway length be 1.67 times greater than the actual landing rollout length (as measured in dry conditions). If the runway is water-affected, this increases to 1.92. This is also known as the '115 per cent rule' (FAA, 1965).
- **Australia** - the Civil Aviation Safety Authority (CASA) has indicated that under Civil Aviation Safety Regulation (CASR) Part 121 (still under development as of early 2009), it will require the actual landing rollout length be 60 to 70 per cent of the total available runway length (CASA, 2002a). This is the same as the 1.67/1.92 factors required by the FAA and JAA.
- **United Kingdom** - The Civil Aviation Authority requires that the total available runway length be 1.92 times greater than the actual landing rollout length (dry). This applies irrespective of the runway conditions at the destination airport (CAA, 2006).

At a minimum, the FAA also recommends use of the '70 per cent rule' when pilots are calculating the required runway length before landing. This rule states that the actual rollout length should never be more than 70 per cent of the total available runway length available at the destination airport, irrespective of the prevailing conditions (FAA, 2007).

6.3.2 Runway condition reporting standards

How wet is wet?

Water is the most common runway contaminant dealt with by pilots and is a contributing factor in many runway excursion accidents. But how does a pilot know that a runway is water-affected to the point where landing could be unsafe? Is there standing water on the runway? How wet is 'wet'? These are questions for which no clear answers are available as there is no international standard for reporting contaminated and water-affected runways (FAA, 2007).

Definitions for wet or water-affected runway conditions have not been published by the FAA or CASA. However, the FAA does define a runway as contaminated whenever standing water, ice, snow, slush, frost, heavy rubber or other substances are present (FAA, 1978).

International Civil Aviation Organization (ICAO) Annex 14 *Aerodrome Design and Operations* provides very general definitions for water-affected runways (ICAO, 2004):

- **Damp** – the surface shows a change in colour due to moisture
- **Wet** – the surface is soaked, but there is no standing water
- **Water patches** – significant patches of standing water are visible
- **Flooded** – extensive standing water is visible.

The JAA provides more detailed definitions for both water-affected and contaminated runways. Some aircraft manufacturers provide these JAA definitions as supplemental data in their AFMs (FAA, 2007; ATSB, 2001).

- **Dry runway** - a dry runway is one that is neither wet nor contaminated, and includes paved runways that have been specifically prepared with grooves or porous pavement and maintained to retain ‘effectively dry’ braking action even when moisture is present.
- **Damp runway** - a runway is considered damp when the surface is not dry, but moisture on it does not give a shiny appearance.
- **Wet runway** - a runway is considered wet when there is sufficient moisture on the surface to cause it to appear reflective, but without significant areas of standing water.
- **Contaminated runway** - a runway is considered contaminated when more than 25 per cent of the runway surface area (whether in isolated areas or not) within the required length and width being used, is covered by:
 - surface water more than 3 mm (1/8”) deep
 - slush or loose snow equivalent to more than 3 mm (1/8”) of water
 - ice, including wet ice.

The FAA has taken the position that a runway does not need to be reflective to be considered wet. If a runway is contaminated or not dry, that runway is considered wet (FAA, 2007).

Clear definitions for reporting runway conditions are important so that air traffic controllers can accurately communicate this information to pilots in a standardised, quantified way. This will allow pilots to make more informed decisions about the impact of prevailing runway conditions on the landing rollout length of their aircraft.

CASR Part 121 will consolidate the rules for large aircraft transport operations in Australia. It is intended that it will include definitions of contaminated and water-affected runways based on the existing JAA definitions (CASA, 2002b).

Braking action definitions

Definitions of braking action are another area where there is little standardisation between pilots, industry and regulators. It is common practice in pilot reports to refer to braking action as 'good', 'medium' or 'poor' when describing water-affected or contaminated runways. There are many different definitions of these terms, and their use may lead flight crews into:

- believing that a runway is safe to use for their aircraft when it may not actually be;
- miscalculating the landing rollout length; or
- configuring the aircraft incorrectly for the landing.

The Australian Aeronautical Information Publication (AIP) and the Jeppesen Route Manual provide some generic definitions of these terms (ATSB, 2001).

- **Good** – Although not as good as a dry runway, there should not be any directional control or braking difficulties because of the runway conditions.
- **Medium** – braking action may be such that the achievement of a satisfactory landing or accelerate-stop performance, taking into account the prevailing circumstances, depends on precise handling techniques.
- **Poor** – there may be a significant deterioration both in braking performance and directional control.

These terms are quite broad in definition, however, some aircraft flight manuals and operator SOPs provide Mu values that correlate with good, medium or poor braking action. Appendix D provides FAA/ICAO/industry-agreed braking action definitions, with their estimated Mu correlations.

Where Mu values are recorded, they are reported to pilots by air traffic control. While Mu values provide useful information to pilots to help judge the braking performance of their aircraft, they are estimates only. These values can vary significantly depending on measuring techniques, the time of measurement, and the material/s contaminating the runway. The FAA does not support the use of Mu values alone in estimating an aircraft's braking capability on wet and contaminated runways as they may overstate braking potential (FAA, 2007).

Furthermore, studies of aircraft landing performance on wet and contaminated runways in Western Europe have shown that there is no correlation between pilot reports and the actual friction coefficients of a runway (ATSB, 2001).

Runway condition advisory services

As discussed in Chapter 4, ambiguity of information is a contributing factor to flight crew technique and decision errors. Less than adequate runway condition information in heavy precipitation is a safety issue and a potential contributing factor to runway excursion accidents. Where this information does exist, it is often conflicting (reported by multiple sources), generic (uses general terms), misleading (only applicable to certain aircraft types), or outdated (due to the dynamic nature of weather).

Where runway information is available to pilots, they may use Mu friction values as an indication of the runway condition. These are sometimes unreliable (as discussed

above 6.3.2). On wet runways, there is generally little information available to flight crews on the depth of any standing water on the runway.

There is no international consensus on how runway condition information from preceding aircraft should be interpreted. In the Airbus A340 overrun at Toronto in 2005, runway braking action reports that were passed to, and acknowledged by the A340 flight crew, were generated by much smaller regional jet aircraft. The likely braking effectiveness for large commercial jet aircraft compared with regional jet aircraft is clearly very different, yet there was no information available to the flight crew to help them quantify this difference (TSB, 2007).

7

SYSTEMS-RELATED FACTORS IN RUNWAY EXCURSION ACCIDENTS

Systems-related factors account for 13 per cent of all factors contributing to the 120 runway excursions between 1998 and 2007 identified in the Ascend World Aircraft Accident Summary (WAAS), (Ascend, 2007). This is on-par with the proportion to which performance-related factors contribute to these types of accidents. However, systems-related factors were involved in a greater number of accidents (40); one-third of all runway excursions that occurred during the landing phase of flight.

Systems factors differ from other types of factors that contribute to runway excursion accidents in that they are often outside the control of the flight crew. They include: mechanical failure of braking devices, rendering them inoperative or causing them to behave unexpectedly (such as asymmetric reverse thrust); a loss of directional control and braking on rollout due to aquaplaning or other types of runway contamination; or an in-flight system or structural failure of the aircraft.

Figure 30 presents a breakdown of how frequently different types of systems-related factors were involved in the 40 runway excursion accidents where these types of contributing factors were identified. Suspected or confirmed aquaplaning was the dominant systems-related factor involved in overruns and veer-offs, accounting for almost half (43 per cent) of the probable systems-related contributing factors. Failures or unexpected operation of braking devices (such as spoilers and thrust reversers) were also significant.

Figure 30: Breakdown of systems-related factors across 29 runway excursions on landing, 1998 to 2007

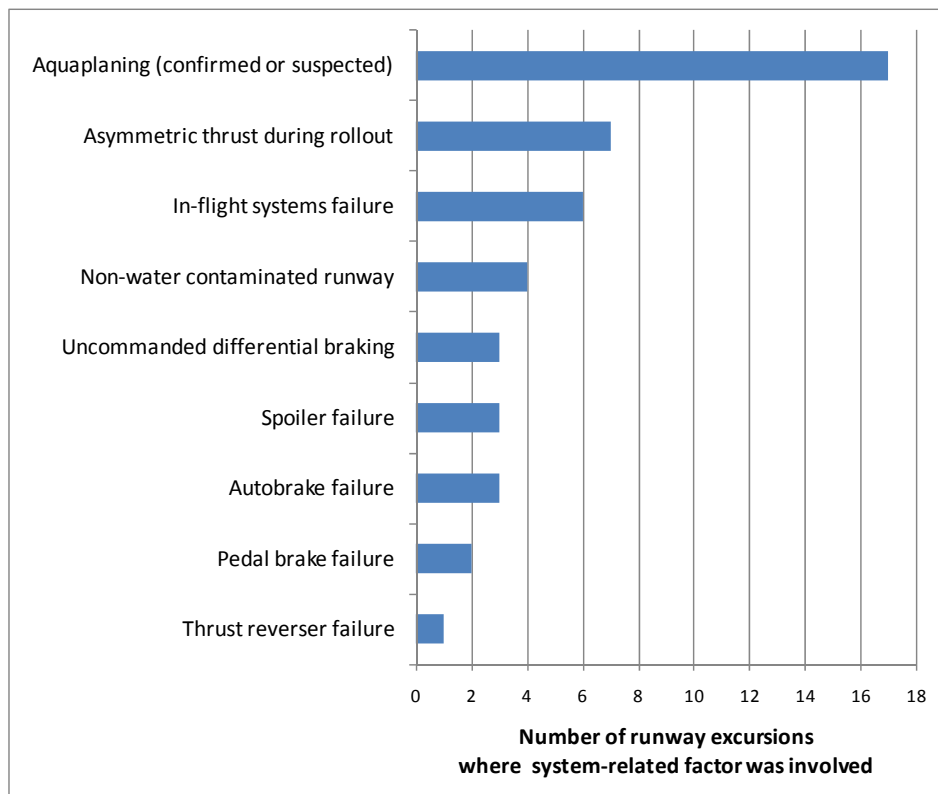

This chapter discusses common systems-related problems, and how they can increase the risk of an overrun or veer-off occurring.

7.1 Aquaplaning

Aquaplaning (also known as hydroplaning) is a major contributor to runway excursion accidents. It significantly reduces the runway friction coefficient (by up to 95 per cent compared to a dry runway) and the flight crew's ability to stop the aircraft or maintain directional control. Aquaplaning is often associated with periods of heavy rain, localised thunderstorm activity, shifting winds, and reduced visibility. Aquaplaning results in a partial or total loss of contact between the tyre and runway as the tyre rides above the runway surface on a film or wedge of standing water (FSF, 2000f).

Both main wheel braking effectiveness and nosewheel steering are reduced in aquaplaning conditions.

- **Main wheel aquaplaning** - some of the main wheels may aquaplane while others may not, causing the aircraft to skid to one side. This is caused by pools of standing water. Main wheel aquaplaning can lead to veer-offs, and reduce the effectiveness of wheel brakes in decelerating the aircraft.
- **Nosewheel aquaplaning** - the nosewheel can aquaplane if it is used by the pilot to steer the aircraft on a wet runway at speeds above taxiing speed. Aquaplaning results in a loss of nosewheel cornering force, and a subsequent loss of directional control. The aircraft will veer off the side of the runway if the pilot cannot regain directional control.

There are three types of aquaplaning, each with varying severities (ATSB, 2001).

- **Viscous** – caused by a thin film of water on the runway that acts as a lubricant and reduces the runway friction coefficient (μ). Viscous aquaplaning is the most common type of aquaplaning and can occur on damp or contaminated runways at low taxi speeds or higher.
- **Dynamic** – caused by hydrodynamic force lifting the tyre off the runway, resulting in the aircraft 'water-skiing' and a substantial loss of friction. Dynamic aquaplaning can occur with standing water as little as 3 mm deep (to be greater than the tyre tread depth), and a ground speed higher than the critical dynamic aquaplaning speed V_p . For a Boeing 747-400 with a tyre pressure of 210 psi (1,448 kPa), this can be as low as 111 kts. This is significantly slower than the Boeing 747 typical approach and landing speed of between 140 and 160 kts (Boeing, 2007).
- **Reverted-rubber** – occurs when a wheel 'locks up' on landing and is dragged across a wet runway. Steam is generated by friction that lifts the tyre off the runway, and heats the tyre surface until it reverts back to its unvulcanised (i.e. uncured, sticky and deformable) state. Reverted-rubber aquaplaning can occur at any speed over 20 kts and reduces the μ value similar to that when landing on an icy runway.

On some aircraft with wing-mounted engines, the use of maximum reverse thrust to decelerate in heavy rain has also been shown to increase the risk of aquaplaning. The reverser flow pushes water in front of the main wheels and may cause localised aquaplaning on runways that are already water-affected (Ranganathan, 2006).

The risk of aquaplaning can be reduced by making a positive touchdown, use of reverse thrust to reduce ground speed, and increasing the wheel loading by having all wheels on the ground and deploying ground spoilers. Aquaplaning at touchdown may prevent various aircraft deceleration systems from activating as the wheels will not be able to spin up (i.e. start rotating, as there is no friction with the runway surface). This reinforces the importance of a firm, positive touchdown to increase wheel loading and maximise braking action (FSF, 2000f).

7.2 Runway design

While not a direct cause in most situations, limitations in runway design and/or space around airports can be a latent failure point that may turn an overrun or veer-off from a safety incident into a catastrophe.

Less than adequate runway design or maintenance can result in surface water drainage problems and the formation of standing water pools. Insufficient runway camber, runway misalignment relative to prevailing winds, or the formation of potholes or depressions in the runway surface are all indicators of less than adequate runway design and maintenance. A higher than normal risk of aquaplaning exists on these runways if they are water-affected.

Runway excursions (overruns and veer-offs) are an all too common occurrence in commercial aviation, accounting for a significant proportion of approach and landing accidents, and making up a quarter of all incidents and accidents in commercial air transport operations (IFALPA, 2008).

The purpose of this report was to characterise runway excursion accidents involving commercial jet aircraft – when they happen, how and why they happen.

The analysis of 141 runway excursion accidents between 1998 and 2007 involving the worldwide commercial jet aircraft fleet showed that these types of accidents have been responsible for over 550 fatalities in the last ten years. Excursions during the landing phase of flight accounted for 120 of these excursion accidents.

A range of flight crew technique and decision-, weather-, flight crew performance-, and systems-related factors were identified as contributing to runway excursion accidents during the landing phase of flight. These include:

- flying an unstabilised approach;
- landing too fast, too far down the runway, or conducting an extended flare;
- delayed or incorrect flight crew action when using braking systems, and less than adequate awareness of minimum equipment list items and their effect on braking performance;
- press-on-itis, and not conducting a go-around or diversion when conditions for landing are unsafe or at a higher risk;
- fatigue, stress, and visual illusions;
- less than adequate awareness of the effect of weather on the landing rollout length, possibly due to inconsistent or a lack of adequate approach and landing standard operating procedures;
- water-affected and contaminated runways, often associated with aquaplaning;
- inconsistent reporting of runway conditions and braking action at airports across the world; and
- unusual runway design or lighting at some airports.

If not identified and effectively managed by the flight crew, these factors can increase the risk of an accident occurring.

The current study is the first in a two-part series of reports on the subject of runway excursion accidents. The second report in this series will:

- discuss the impact of runway excursion accidents in the Australian context;
- explore procedural and physical safeguards that could assist airline and airport operators to reduce the frequency of runway excursion accidents, and minimise the physical damage often associated with those accidents; and
- identify what safeguards are provided at Australian airports to safely control a runway excursion, by means of a survey of airport operators.

Fortunately, Australia has not yet experienced a fatal runway excursion accident as has occurred in some other countries. However, in the last decade, there have been

three notable runway excursion events involving commercial jet aircraft operated by Australian airlines. It is important to recognise that the risk of a runway excursion accident is ever present and that a range of safety measures should be utilised by aircraft operators, and airport owners and managers to ensure the risk remains at an acceptable level.

- Air Safety Week. (2002). Overrun Highlights Hazard of Unstabilized Approaches. *Air Safety Week*, August 26. Retrieved 19 March 2008, from http://findarticles.com/p/articles/mi_m0UBT/is_33_16.
- Ascend. (2007). *World Aircraft Accident Summary, 1990-2007*, London: Airclaims.
- Australian Transport Safety Bureau. (2001). *Boeing 747-438 VH-OJH, Bangkok, Thailand, 23 September 1999* (Aviation Safety Investigation Report 199904538). Canberra: ATSB, Department of Transport and Regional Services.
- Australian Transport Safety Bureau. (2004). *Runway overrun at Darwin International Airport, Boeing 737-800 VH-VOE, 11 June 2002* (Aviation Safety Investigation Report 200202710). Canberra: ATSB, Department of Transport and Regional Services.
- Australian Transport Safety Bureau. (2005). *Boeing Co 737-376, VH-TJB, 19 February 2003* (Aviation Safety Investigation Report 200300418). Canberra: ATSB, Department of Transport and Regional Services.
- Aviation Safety Network. (2008). ASN Aviation Safety Database. Retrieved 17 November 2008, from <http://aviation-safety.net/database>.
- Ayres, M. (2007). *ACRP 4-01, Aircraft Overrun and Undershoot Analysis for Runway Safety Areas*. Paper presented at the 30th Federal Aviation Administration Annual Airport Conference, Airports – Eastern Region, Hershey, PA.
- Boeing. (2006). *Statistical Summary of Commercial Jet Airplane Accidents, Worldwide Operations, 1959-2005*. Seattle, WA: Boeing Commercial Airplanes.
- Boeing. (2007). *Airport Reference Code and Approach Speeds for Boeing Airplanes*. Seattle, WA: Boeing Commercial Airplanes.
- Boeing. (2008). *Statistical Summary of Commercial Jet Airplane Accidents, Worldwide Operations, 1959-2007*. Seattle, WA: Boeing Commercial Airplanes.
- Brandt, S., Stiles, R., Bertin, J. & Whitford, R. (1997). *Introduction to Aeronautics: A Design Perspective*. Reston, VA: American Institute of Aeronautics and Astronautics.
- Civil Aeronautics Board (Philippines). (2000). *Aircraft Investigation Report on the Accident of Philippine Airlines' Flight PR137 on the Manila-Bacolod-Manila route Last March 22, 1998*. Manila: Air Transportation Office, Department of Transportation and Communication.
- Civil Aviation Authority (United Kingdom). (2006). *Landing performance of large transport aeroplanes* (Aeronautical Information Circular AIC 14/2006). Hounslow, Middlesex: Aeronautical Information Service, National Air Traffic Services Ltd.
- Civil Aviation Safety Authority. (2002a). *Aircraft performance* (Advisory Circular AC 121A-06(0)). Canberra: CASA.
- Civil Aviation Safety Authority. (2002b). *Notice of Proposed Rule Making, Air Transport Operations – Large Aeroplanes, Proposed Part 121A of the Civil Aviation Safety Regulations (CASRs)* (Document NPRM 02110S). Canberra: CASA.

- Edwards, D., Douglas, J. & Edkins, G. (1998). Situation awareness. *Flight Safety Australia*, November, 15-17.
- Federal Aviation Administration. (1965). *Airplanes: Turbine engine powered: Landing limitations: Destination airports* (Federal Aviation Regulation FAR 121.195). Washington, DC: FAA, United States Department of Transportation.
- Federal Aviation Administration. (1978). *Water, Slush, and Snow on the Runway* (Advisory Circular AC 91-6A). Washington, DC: FAA, United States Department of Transportation.
- Federal Aviation Administration. (2007). *Runway Overrun Prevention* (Advisory Circular AC 91-79). Washington, DC: FAA, United States Department of Transportation.
- Flight Safety Foundation. (2000a). FSF ALAR Briefing Note 5.3 – Visual Illusions (ALAR Tool Kit). *Flight Safety Digest*, August-November, 103-109.
- Flight Safety Foundation. (2000b). FSF ALAR Briefing Note 7.1 – Stabilized Approach (ALAR Tool Kit). *Flight Safety Digest*, August-November, 133-138.
- Flight Safety Foundation. (2000c). FSF ALAR Briefing Note 8.1 – Runway Overruns and Runway Excursions (ALAR Tool Kit). *Flight Safety Digest*, August-November, 159-162.
- Flight Safety Foundation. (2000d). FSF ALAR Briefing Note 8.3 – Landing Distances (ALAR Tool Kit). *Flight Safety Digest*, August-November, 167-171.
- Flight Safety Foundation. (2000e). FSF ALAR Briefing Note 8.4 – Braking Devices (ALAR Tool Kit). *Flight Safety Digest*, August-November, 173-177.
- Flight Safety Foundation. (2000f). FSF ALAR Briefing Note 8.5 – Wet or Contaminated Runways (ALAR Tool Kit). *Flight Safety Digest*, August-November, 179-184.
- Flight Safety Foundation. (2000g). FSF ALAR Briefing Note 8.7 – Crosswind Landings (ALAR Tool Kit). *Flight Safety Digest*, August-November, 189-196.
- International Civil Aviation Organization. (2004). *Annex 14 to the Convention on International Civil Aviation, Aerodromes, Volume 1, Aerodrome Design and Operations* (4th edition). Montreal: ICAO.
- International Civil Aviation Organization. (2007). *Runway Safety Area Improvements in the United States*. Paper presented at the ninth meeting of Directors of Civil Aviation of the Central Caribbean (C/CAR/DCA/9), ICAO, Oranjestad, Aruba, Netherlands Antilles, agenda item 2.3.
- International Federation of Air Line Pilots' Associations. (2008). *Runway End Safety Areas (RESAs)* (08POS01) (Position statement). Chertsey, Surrey: IFALPA.
- Industry Safety Strategy Group. (2006). *Implementing the Global Aviation Safety Roadmap*. Montreal: ISSG, International Civil Aviation Organization.
- Jane's All the World's Aircraft. (2008). The Boeing Company – Boeing 787 Dreamliner. Retrieved 27 March 2008, from <http://www.janes.com>.
- Khatwa, R. & Helmreich, R. (1999). Analysis of Critical Factors During Approach and Landing in Accidents and Normal Flight – Data Acquisition and Analysis Working Group Final Report. *Flight Safety Digest*, November-December, 1-77.

- Kirkland, I., Caves, R., Humphreys, I. & Pitfield, D. (2004). *An improved methodology for assessing risk in aircraft operations at airports, applied to runway overrun*. Amsterdam: Elsevier.
- Lacagnina, M. (2008a). Snowed. *AeroSafety World*, September, 22-27.
- Lacagnina, M. (2008b). High, Hot and Fixated. *AeroSafety World*, January, 42-46.
- Lissys (Piano). (2006). *Boeing 787-8 Dreamliner: Analysis*. Retrieved 27 March 2008, from <http://www.lissys.demon.co.uk/samp1/index.html>.
- McKinney, D. (2006). *Preventing Runway Overruns or Excursions*. Paper presented at the 18th European Aviation Safety Seminar (EASS), Flight Safety Foundation, Athens.
- Merritt, A. & Klinect, J. (2006). *Defensive Flying for Pilots: An Introduction to Threat and Error Management*. Austin, TX: The University of Texas.
- National Transportation Safety Board. (2001). *Runway Overrun During Landing, American Airlines Flight 1420, McDonnell Douglas MD-82, N215AA, Little Rock, Arkansas, June 1, 1999* (Aircraft Accident Report NTSB/AAR-01/02). Washington, DC: NTSB.
- National Transportation Safety Board. (2007). *Runway Overrun and Collision, Southwest Airlines Flight 1248, Boeing 737-7H4, N471WN, Chicago Midway International Airport, Chicago, Illinois, December 8, 2005* (Aircraft Accident Report NTSB/AAR-07/06). Washington, DC: NTSB.
- National Transportation Safety Board. (2008). *NTSB Investigates Jetliner Runway Excursion in Jackson Hole*. Retrieved 22 December 2008, from <http://www.nts.gov/pressrel/2008/080227.html>.
- National Transportation Safety Committee (Indonesia). (2007). *Boeing 737-497, PK-GZC, Adisucipto Airport, Yogyakarta, Indonesia, 7 March 2007* (Aircraft Accident Investigation Report KNKT/07.06/07.02.35). Jakarta: NTSC, Ministry of Transportation.
- Onnettomuustutkintakeskus (Finland). (1997). *Aircraft incident at Turku airport, Finland on 30.12.1997* (Aircraft Incident Report B 9/1997 L). Helsinki: Onnettomuustutkintakeskus.
- Orasanu, J. & Martin, L. (1998). *Errors in Aviation Decision Making: A Factor in Accidents and Incidents*. Paper presented at the first annual workshop on Human Error, Safety, and System Development (HESSD), Glasgow.
- Ranganathan, A. (2006). Wet Runway Overruns: Pilot Error? System Deficiency? *ISASI Forum* (International Society of Air Safety Investigators), 39(1), January-March, 6-8.
- Ranter, H. (2006). *Airliner Accident Statistics 2005*, Flight Safety Foundation. Retrieved 10 December 2007, from <http://aviation-safety.net/database>.
- Transportation Safety Board of Canada. (1997). *Loss of Control on Go-around (Rejected Landing), Air Canada Canadair CL-600-2B19 C-FSKI, Fredericton Airport, New Brunswick, 16 December 1997* (Aviation Investigation Report A97H0011). Gatineau, Quebec: TSB. Retrieved 19 November 2008, from <http://www.tsb.gc.ca/eng/rapports-reports/aviation/1997/a97h0011/a97h0011.asp>.

Transportation Safety Board of Canada. (2006). *Runway Excursion, Air Canada Airbus A319-112 C-GJTC, Winnipeg International Airport, Manitoba, 26 December 2005* (Aviation Investigation Report A05C0222). Gatineau, Quebec: TSB. Retrieved 15 December 2008, from <http://www.tsb.gc.ca/eng/rapports-reports/aviation/2005/a05c0222/a05c0222.asp>.

Transportation Safety Board of Canada. (2007). *Runway overrun and fire: Air France Airbus A340-313 F-GLZQ, Toronto/Lester B. Pearson International Airport, Ontario, 02 August 2005* (Aviation Investigation Report A05H0002). Gatineau, Quebec: TSB.

van Es, G. & Karwal, A. (2001). *Safety aspects of tailwind operations*. Amsterdam: Nationaal Lucht-en Rulmtevaartlaboratorium (NLR).

van Es, G. (2005). *Running out of runway: Analysis of 35 years of landing overrun accidents*. Amsterdam: Nationaal Lucht-en Rulmtevaartlaboratorium (NLR).

Werfelman, L. (2008). Safety on the Straight and Narrow. *AeroSafety World*, August, 12-17.

Wickens, C. D. & Hollands, J. G. (2000). *Engineering Psychology and Human Performance* (4th ed.). Upper Saddle River, NJ: Prentice-Hall.

Wyatt, K. (2008). Firefighter: Miracle no one died on Denver runway. *Associated Press*, December 21. Retrieved 22 December 2008, from http://hosted.ap.org/dynamic/stories/A/AIRPORT_ACCIDENT?SITE=AP&SECTION=HOME&TEMPLATE=DEFAULT&CTIME=2008-12-21-15-13-59

10 APPENDICES

10.1 Appendix A – Sources and submissions

10.1.1 Sources of information

The primary sources of information used during this investigation were:

- the Ascend World Aircraft Accident Summary (WAAS);
- the aviation accident and incident database of the Australian Transport Safety Bureau (ATSB);
- ATSB aviation safety investigation reports; and
- accident investigation reports published by the United States National Transportation Safety Board (NTSB), the Transportation Safety Board of Canada (TSB), the National Transportation Safety Committee of Indonesia (NTSC), and other international aviation safety investigation bodies.

A full list of data sources is provided in the Methodology (Chapter 2) and References (Chapter 9).

10.1.2 Submissions

A draft of this report was provided to the Civil Aviation Safety Authority (CASA), the Department of Infrastructure, Transport, Regional Development and Local Government, and the Australian Airports Association.

Submissions were received from CASA and the Department of Infrastructure, Transport, Regional Development and Local Government. The submissions were reviewed and where considered appropriate, the text of the report was amended accordingly.

10.2 Appendix B - Worldwide runway excursion accidents, 1998 to 2007, as identified from the Ascend World Aircraft Accident Summary

10.2.1 Landing accidents

Date	Aircraft manufacturer	Aircraft model	Registration	Location (airport)	Location (country)	Total fatalities
11/01/98	Avro	RJ100	TC-THF	Samsun Airport, Samsun	Turkey	0
26/02/98	Fokker	100	N867US	Municipal Airport, Birmingham, Alabama	United States	0
22/03/98	Airbus	A320	RP-C3222	Bacolod Airport, Bacolod	Philippines	0
12/04/98	Boeing	737-200	P4-NEN	Almaty International Apt, Almaty	Kazakhstan	0
16/05/98	Fokker	F28-4000	PK-VFY	Seletar Airport	Singapore	0
21/05/98	Airbus	A320	G-UKLL	Ibiza Airport	Spain	0
21/05/98	Boeing	737-400	TC-AZA	Ataturk Airport, Istanbul	Turkey	0
19/07/98	Boeing	737-200	ST-AFL	Khartoum Airport, Khartoum	Sudan	0
5/08/98	Boeing	747-400	HL7496	Kimpo International Airport, Seoul	South Korea	0
11/09/98	Boeing	767-300	N316UP	Ellington Field, Houston, Texas	United States	0
16/09/98	Boeing	737-500	N20643	Miguel Hidalgo Airport, Guadalajara	Mexico	0
22/09/98	Fokker	F28-3000	FAC1141	La Vanguardia Airport, Villavicencio	Columbia	0
30/09/98	McDonnell Douglas	MD-82	HL7236	Ulsan Airport, Ulsan	South Korea	0
1/11/98	Boeing	737-200	EI-CJW	Hartsfield International Airport, Atlanta, Georgia	United States	0
14/11/98	Boeing	707-320	5N-VRG	Ostend Airport, Ostend	Belgium	0
10/02/99	Boeing	737-200	PK-IJH	Hasanudin Airport, Ujing, Padang, Sulawesi	Indonesia	0
4/03/99	Boeing	737-200	F-GBYA	Parne Airport, Biarritz	France	0
15/03/99	McDonnell Douglas	MD-83	HL77570	Pohang Airport, Pohang,	South Korea	0
20/03/99	Airbus	A321	SU-GBT	Luxor Airport, Luxor	Egypt	0
24/03/99	Airbus	A300-620C	A6-PFD	Diagoras Airport, Rhodes	Greece	0
5/04/99	Boeing	737-200	PK-RIL	Hasanudin International Airport, Ujung Pandang, Sulawesi	Indonesia	0
10/05/99	Boeing	737-200	XC-UJI	Loma Bonita Airport,	Mexico	0

Date	Aircraft manufacturer	Aircraft model	Registration	Location (airport)	Location (country)	Total fatalities
1/06/99	McDonnell Douglas	MD-82	N215AA	National Airport, Little Rock, Arkansas	United States	11
28/06/99	Airbus	A310	N420FE	Ninoy Aquino International Airport	Philippines	0
1/08/99	Fokker	F28-1000	C-GTIZ	St John's International Airport, Newfoundland	Canada	0
8/08/99	McDonnell Douglas	MD-11	B-2175	Hongqiao Airport, Shanghai	China	0
13/08/99	Fokker	F28-1000	XY-ADU	Mingaladon Airport, Yangon	Myanmar	0
14/08/99	Boeing	707	ST-ANP	Juba Airport, Juba	Sudan	0
2/09/99	Boeing	747	B-18253	Chiang Kai Shek, Taipei	Taiwan	0
13/09/99	Airbus	A320	EC-GRF	Sondica Airport, Bilbao	Spain	0
14/09/99	Boeing	757	G-BYAG	Costa Brava Airport, Gerona	Spain	1
23/09/99	Boeing	747	VH-OJH	Bangkok International Airport	Thailand	0
16/10/99	Douglas	DC-8	9G-REM	N'Djili Airport, Kinshasa	DR Congo	0
17/10/99	McDonnell Douglas	MD-11	N581FE	Subic Bay International Airport, Olongapo	Philippines	0
21/12/99	McDonnell Douglas	DC-10	F-GTDI	La Aurora Airport, Guatemala City	Guatemala	16
22/02/00	Boeing	767	SU-GAO	Harare International Airport, Harare	Zimbabwe	0
27/02/00	Boeing	737	PT-TEO	Salgado Filho Airport, Port Alegre	Brazil	0
1/03/00	Airbus	A320	ZS-SHD	Lusaka Airport, Lusaka	Zambia	0
5/03/00	Boeing	737	N668SW	Burbank International Airport, Burbank	United States	0
22/04/00	Avro	RJ70	TC-THL	Siirt Airport, Siirt	Turkey	0
30/04/00	McDonnell Douglas	DC-10	N800WR	Entebbe International Airport, Entebbe	Uganda	0
14/06/00	Douglas	DC-9	XA-DEI	Miguel Hidalgo Airport, Guadalajara	Mexico	0
26/06/00	Boeing	737	7O-ACQ	Khartoum Airport, Khartoum	Sudan	0
6/10/00	Douglas	DC-9	N936ML	General Lucio Blanco Airport, Reynosa	Mexico	0
5/11/00	Boeing	747	TJ-CAB	Charles de Gaulle Airport, Paris	France	0
23/12/00	McDonnell Douglas	DC-10	N132AA	Faa Airport, Papeete	French Polynesia	0
20/03/01	Airbus	A320	TS-IMM	Melita Airport, Djerba	Tunisia	0

Date	Aircraft manufacturer	Aircraft model	Registration	Location (airport)	Location (country)	Total fatalities
17/05/01	Airbus	A300	HS-TAX	Bangkok International Airport	Thailand	0
10/06/01	Embraer	ERJ-145	B-3040	Capital Airport, Beijing	China	0
17/07/01	Fokker	F28	HC-1984	Tulcan Airport, Tulcan	Ecuador	0
1/08/01	Boeing	727	7O-ACW	Asmara International Airport, Asmara	Eritrea	0
19/08/01	Boeing	737	D-AHIA	Ataturk Airport, Istanbul	Turkey	0
28/08/01	BAC	111	5N-BDC	Libreville Airport, Libreville	Gabon	0
1/11/01	Boeing	737	5Y-KQD	Jomo Kenyatta International Airport, Nairobi	Kenya	0
26/04/02	Boeing	707	9Q-CKB	N'Djili Airport, Kinshasa	DR Congo	0
14/06/02	Douglas	DC-9	HK-3859X	La Margarita Airport, Neiva	Columbia	0
16/08/02	Boeing	737	B-2521	Lijiang City Airport, Lijiang	China	0
28/08/02	Airbus	A320	N635AW	Sky Harbor International Airport, Phoenix	United States	0
31/10/02	Douglas	DC-9	XA-AMF	Gen. Mariano Escobedo Airport, Monterrey	Mexico	0
13/12/02	Douglas	DC-8	N1804	Changi International Airport	Singapore	0
6/01/03	Embraer	ERJ-145	N16571	Cleveland Hopkins International, Cleveland	United States	9
23/01/03	Boeing	737	PK-ALV	Soekarno-Hatta International Airport, Jakarta	Indonesia	0
15/02/03	Boeing	747	N485EV	Signonella AFB, Ctania, Sicily	Italy	0
21/03/03	Boeing	737	CN-RMX	Menara Airport, Marrakech	Morocco	0
30/03/03	Boeing	767	EI-CXO	Jose Marti International Airport, Havana	Cuba	0
24/05/03	Boeing	737	N343SW	Amarillo International Airport, Amarillo	United States	0
6/07/03	McDonnell Douglas	DC-10	OB-1749	Afonso Pena Airport, Curitiba	Brazil	0
24/09/03	Embraer	ERJ-145	LX-LGZ	Findel Airport, Luxembourg	Luxembourg	0
1/10/03	Boeing	747	4X-ICM	Bierset Airport, Liege	Belgium	0
1/11/03	Airbus	A321	SU-GBU	Donodedovo Airport, Moscow	Russia	0
6/11/03	Airbus	A320	PT-MZL	Hercilio Luz Airport, Florianopolis	Brazil	0

Date	Aircraft manufacturer	Aircraft model	Registration	Location (airport)	Location (country)	Total fatalities
7/12/03	Fokker	F28	5Y-NNN	Lockichogio Airport, Lockchogio	Kenya	0
19/12/03	Boeing	737	TR-LFZ	Leon M'Ba Airport, Libreville	Gabon	0
20/12/03	Boeing	737	PR-GOO	Linhas Aereas Ministro Victor Konder Airport, Navegantes	Brazil	0
28/04/04	McDonnell Douglas	DC-10	N189AX	Eldorado Airport, Bogota	Columbia	0
29/04/04	Boeing	737	TC-JGD	Gaziantep Airport, Gaziantep	Turkey	0
17/06/04	Airbus	A300	SU-BDG	Khartoum Airport, Khartoum	Sudan	0
8/10/04	Fokker	F28	S2-ACH	Osmany International Airport, Sylhet	Bangladesh	0
18/10/04	Airbus	A320	B-22310	Sung Shan Airport, Taipei	Taiwan	0
7/11/04	Boeing	737	9M-AAP	Kota Kinabalu International Airport, Kota Kinabalu	Malaysia	0
28/11/04	Boeing	737	PH-BTC	Barcelona International Airport, Barcelona	Spain	0
30/11/04	McDonnell Douglas	MD-82	PK-LMN	Adi Sumarmo Airport, Solo, Java	Indonesia	25
24/01/05	Boeing	747	N808MC	Dusseldorf International Airport, Dusseldorf	Germany	0
25/01/05	Fokker	100	YU-AOM	Podgorica International Airport, Podgorica	Yugoslavia	0
25/02/05	Boeing	727	YK-AGA	Kuwait International Airport, Kuwait City	Kuwait	0
7/03/05	Airbus	A310	F-OJHH	Mehrabad International Airport, Tehran	Iran	0
11/03/05	Canadair	RJ 440	N8932C	General Mitchell International Airport, Milwaukee	United States	0
14/04/05	Boeing	737	PK-MBQ	Nusantara Hasanuddin Airport, Makassar, Ujung	Indonesia	0
20/04/05	Boeing	707	EP-SHE	Mehrabad International Airport, Tehran	Iran	3
1/06/05	Airbus	A320	EK-32009	Vnukovo International Airport, Moscow	Russia	0
1/07/05	McDonnell Douglas	DC-10	S2-AND	Shah Amanat International Airport, Chittagong	Bangladesh	0
5/07/05	Airbus	A320	S7-ASH	Siem Reap International Airport, Siem Reap	Cambodia	0

Date	Aircraft manufacturer	Aircraft model	Registration	Location (airport)	Location (country)	Total fatalities
12/07/05	Boeing	737-700	6V-AHN	Gbessia Airport, Conakry	Guinea	0
2/08/05	Airbus	A340	F-GLZQ	Pearson International Airport, Toronto	Canada	0
9/10/05	Boeing	737	VT-SID	Chhatrapati Shivaji International Airport, Mumbai	India	0
31/10/05	Boeing	727	9Q-CPJ	Kindu International Airport	DR Congo	0
14/11/05	British Aerospace	146	RP-C2995	Catarman Airport, Catarman	Philippines	0
8/12/05	Boeing	737	N471WN	Midway International Airport, Chicago	United States	0
4/03/06	McDonnell Douglas	MD-82	PK-LMW	Juanda Airport, Surabaya	Indonesia	0
4/06/06	McDonnell Douglas	DC-10	N68047	Augusto C Sandino Airport, Magua	Nicaragua	0
23/06/06	McDonnell Douglas	MD-83	SU-BOZ	Juba Airport, Juba	Sudan	0
9/07/06	Airbus	A310	F-OGYP	Irkutsk International Airport, Irkutsk	Russia	126
7/09/06	Boeing	727	ZS-DPF	Murtala Muhammed International Airport, Lagos	Nigeria	0
3/10/06	Boeing	737	PK-RIE	Juwata Airport, Tarakan, Kalimantan	Indonesia	0
10/10/06	British Aerospace	146	OY-CRG	Sorstokken Airport, Stord	Norway	4
17/11/06	McDonnell Douglas	DC-10	N305FE	Ernesto Cortissoz International, Barranquilla	Columbia	0
15/02/07	Airbus	A320	RP-C3223	Tacloban International Airport, Tacloban	Philippines	0
18/02/07	Embraer	170	N862RW	Shuttle America Hopkins International Airport	United States	0
7/03/07	Boeing	737	PK-GZC	Adisucipto Airport, Yogyakarta, Java	Indonesia	22
23/03/07	Airbus	A300	YA-BAD	Ataturk International Airport, Istanbul	Turkey	0
9/04/07	Airbus	A321	I-BIXK	Capodichino International Airport, Naples	Italy	0
12/04/07	Canadair	RJ 200	N8905F	Cherry Capital Airport, Traverse City	United States	0
3/07/07	Boeing	737	VT-SIJ	Cochin Airport, Cochin	India	0
7/07/07	Boeing	737	VT-AXC	Cochin Airport, Cochin	India	0

Date	Aircraft manufacturer	Aircraft model	Registration	Location (airport)	Location (country)	Total fatalities
17/07/07	Embraer	190	HK-4455	Simon Bolivar Airport, Santa Marta	Columbia	0
17/07/07	Airbus	A320	PR-MBK	Congonhas International Airport, Sao Paulo	Brazil	187
16/09/07	McDonnell Douglas	MD-82	HS-OMG	Phuket International Airport	Thailand	90
26/10/07	Airbus	A320	RP-C3224	Butuan Airport, Butuan	Philippines	0
1/11/07	Boeing	737	PK-RIL	Malang Airport	Indonesia	0
9/11/07	Airbus	A340	EC-JOH	Quito International Airport	Ecuador	0

10.2.2 Takeoff accidents

Date	Aircraft manufacturer	Aircraft Model	Registration	Location (airport)	Location (country)	Total fatalities
15/05/98	Fokker	F28-4000	PK-MGT	Nusantara Wolter Monginsidi Ap, Kendari, Sulawesi	Indonesia	0
29/05/98	Boeing	737-500	VT-JAL	Santa Cruz Ap, Mumbai	India	0
12/09/98	Boeing	767-300	S7-RGW	Tan Son Nhat Airport, Ho Chi Minh City	Vietnam	0
31/01/99	Boeing	727-200	7T-VEH	Ain el Bey Airport, Constantine	Algeria	0
7/02/99	Boeing	707-320	9G-ROX	Ivanka Airport, Bratislava	Slovakia	0
19/11/99	Boeing	737	F-GRFA	Charles de Gaulle Airport, Paris	France	0
17/03/01	Airbus	A320	N357NW	Metropolitan Airport, Detroit	United States	0
7/09/01	Boeing	707	TN-AGO	Luano Airport, Lubumbashi	DR Congo	0
14/01/02	Boeing	737	PK-LID	Sultan Syarif Kasim II Airport, Pekanbaru	Indonesia	0
17/01/03	Fokker	F28	HC-1984	Mariscal Sucre Airport, Quito	Ecuador	0
17/06/03	McDonnell Douglas	MD-88	TC-ONP	Eelde Airport, Groningen	Netherlands	0
11/07/03	Boeing	707	5X-AMW	Zia International Airport, Dhaka	Bangladesh	0
9/04/04	Airbus	A340	A6-ERN	Jan Smuts International Airport, Johannesburg	South Africa	0
27/04/04	Boeing	737	UR-VVB	Sheremetyevo Airport, Moscow	Russia	0
11/08/04	Boeing	737	3X-GCM	Lungi International Airport, Freetown	Sierra Leone	0

Date	Aircraft manufacturer	Aircraft Model	Registration	Location (airport)	Location (country)	Total fatalities
14/10/04	Boeing	747	9G-MKJ	Halifax International Airport, Halifax	Canada	7
7/11/04	Boeing	747	TF-ARR	Sharjah International Airport, Sharjah	United Arab Emirates	0
3/06/06	Dornier	328Jet	N328PD	Manassas Regional Airport, Manassas	United States	0
7/06/06	Boeing	747	N922FT	Rio Negro Airport, Medellin	Columbia	0
27/08/06	Canadair	RJ 100	N431CA	Blue Grass Airport, Lexington	United States	49
30/04/07	Boeing	737	CN-RNB	Senou International Airport, Bamako	Mali	0

Appendix C - Flight Safety Foundation contributing factors classification for runway excursion accidents²⁶



Flight Safety Foundation

ALAR

Approach-and-landing Accident Reduction

Tool Kit

FSF ALAR Briefing Note 8.1 — Runway Excursions And Runway Overruns

Runway excursions occur when:

- Aircraft veer off the runway during the landing roll; and,
- Aircraft veer off the runway or taxiway when exiting the runway.

Runway overruns occur when the aircraft roll-out extends beyond the end of the landing runway.

Runway excursions and runway overruns can occur after any type of approach in any light condition or environmental condition.

Statistical Data

The Flight Safety Foundation Approach-and-landing Accident Reduction (ALAR) Task Force found that runway excursions and runway overruns were involved in 20 percent of 76 approach-and-landing accidents and serious incidents worldwide in 1984 through 1997.¹

Factors Involved in Runway Excursions

Runway excursions are usually the result of one or more of the following factors:

Weather Factors

- Runway condition (wet or contaminated by standing water, snow, slush or ice);
- Wind shear;
- Crosswind;

- Inaccurate information on wind conditions and/or runway conditions; and,
- Reverse-thrust effect in a crosswind and on a wet runway or a contaminated runway.

Crew Technique/Decision Factors

- Incorrect crosswind landing technique (e.g., drifting during the transition from a wings-level crosswind approach ["crabbed" approach] to a steady-sideslip crosswind approach, or failing to transition from a wings-level approach to a steady-sideslip approach ["decrab"] when landing in strong crosswind conditions);
- Inappropriate differential braking by the crew;
- Use of the nosewheel-steering tiller at airspeeds that are too fast; and,
- Airspeed too fast on the runway to exit safely.

Systems Factors

- Asymmetric thrust (i.e., forward thrust on one side, reverse thrust on the opposite side); or,
- Uncommanded differential braking.

Factors Involved in Runway Overruns

Runway overruns are usually the result of one or more of the following factors:

Weather Factors

- Unanticipated runway condition (i.e., worse than anticipated);

²⁶ In Appendix C, the term *runway excursions* has the same meaning to what is referred to in this report as runway *veer-offs*.

- Inaccurate surface wind information; and,
- Unanticipated wind shear or tail wind.

Performance Factors

- Incorrect assessment of landing distance following a malfunction or minimum equipment list (MEL)/dispatch deviation guide (DDG) condition affecting aircraft configuration or braking capability; and,
- Incorrect assessment of landing distance for prevailing wind and runway conditions.

Crew Technique/Decision Factors

- Unstable approach path (steep and fast):
 - Landing fast; and,
 - Excessive height over threshold, resulting in landing long;
- No go-around decision when warranted;
- Decision by captain (pilot not flying) to land, countermanding first officer's decision to go around;
- Extended flare (allowing the aircraft to float and to decelerate [bleed excess airspeed] in the air uses typically three times more runway than decelerating on the ground);
- Failure to arm ground spoilers (usually associated with thrust reversers being inoperative);
- Power-on touchdown (i.e., preventing the auto-extension of ground spoilers, as applicable);
- Failure to detect nondeployment of ground spoilers (e.g., absence of related standard call);
- Bouncing and incorrect bounce recovery;
- Late braking (or late takeover from autobrake system, if required); and,
- Increased landing distance resulting from the use of differential braking or the discontinued use of reverse thrust to maintain directional control in crosswind conditions.

Systems Factors

- Loss of pedal braking;
- Anti-skid system malfunction; or,
- Hydroplaning.

Accident-prevention Strategies and Lines of Defense

The following company accident-prevention strategies and personal lines of defense are recommended:

Policies

- Define policy to promote readiness and commitment to go around (discouraging any attempt to "rescue" a situation that is likely to result in a hazardous landing);

- Define policy to ensure that inoperative brakes ("cold brakes") are reported in the aircraft logbook and that they receive attention in accordance with the MEL/DDG;
- Define policy for a rejected landing (bounce recovery);
- Define policy prohibiting landing beyond the touchdown zone; and,
- Define policy encouraging a firm touchdown when operating on a contaminated runway.

Standard Operating Procedures (SOPs)

- Define criteria and standard calls for a stabilized approach, and define minimum stabilization heights in SOPs (Table 1, page 161);
- Define task-sharing and standard calls for final approach and roll-out phases in SOPs; and,
- Incorporate in SOPs a standard call for "... [feet or meters] runway remaining" or "... [feet or meters] to go" in low-visibility conditions, based on:
 - Runway-lighting color change;
 - Runway-distance-to-go markers (as available); or,
 - Other available visual references (such as runway/taxiway intersections).

Performance Data

- Publish data and define procedures for adverse runway conditions; and,
- Provide flight crews with specific landing-distance data for runways with a downhill slope/high elevation.

Procedures

- Publish SOPs and provide training for crosswind-landing techniques;
- Publish SOPs and provide training for flare techniques;
- Publish SOPs for the optimum use of autobrakes and thrust reversers on contaminated runways;
- Provide recommendations for the use of rudder and differential braking/nosewheel steering for directional control, depending on airspeed and runway condition; and,
- Publish specific recommendations for aircraft lateral control and directional control after a crosswind landing.

Crew Awareness

- Ensure flight crew awareness and understanding of all factors affecting landing distances;
- Ensure flight crew awareness and understanding of conditions conducive to hydroplaning;

**Table 1
Recommended Elements
Of a Stabilized Approach**

All flights must be stabilized by 1,000 feet above airport elevation in instrument meteorological conditions (IMC) and by 500 feet above airport elevation in visual meteorological conditions (VMC). An approach is stabilized when all of the following criteria are met:

1. The aircraft is on the correct flight path;
2. Only small changes in heading/pitch are required to maintain the correct flight path;
3. The aircraft speed is not more than $V_{REF} + 20$ knots indicated airspeed and not less than V_{REF} ;
4. The aircraft is in the correct landing configuration;
5. Sink rate is no greater than 1,000 feet per minute; if an approach requires a sink rate greater than 1,000 feet per minute, a special briefing should be conducted;
6. Power setting is appropriate for the aircraft configuration and is not below the minimum power for approach as defined by the aircraft operating manual;
7. All briefings and checklists have been conducted;
8. Specific types of approaches are stabilized if they also fulfill the following: instrument landing system (ILS) approaches must be flown within one dot of the glideslope and localizer; a Category II or Category III ILS approach must be flown within the expanded localizer band; during a circling approach, wings should be level on final when the aircraft reaches 300 feet above airport elevation; and,
9. Unique approach procedures or abnormal conditions requiring a deviation from the above elements of a stabilized approach require a special briefing.

An approach that becomes unstabilized below 1,000 feet above airport elevation in IMC or below 500 feet above airport elevation in VMC requires an immediate go-around.

Source: Flight Safety Foundation Approach-and-landing Accident Reduction (ALAR) Task Force (V1.1 November 2000)

- Ensure flight crew awareness and understanding of crosswind and wheel-cornering issues;
- Ensure flight crew awareness of wind shear and develop corresponding procedures (particularly for the monitoring of groundspeed variations during approach);
- Ensure flight crew awareness of the relationships among braking action, friction coefficient and runway-condition index, and maximum crosswind components recommended for runway conditions; and,
- Ensure flight crew awareness of runway lighting changes when approaching the runway end:

- Standard centerline lighting: white lights changing to alternating red and white lights between 3,000 feet and 1,000 feet from runway end, and to red lights for the last 1,000 feet; and,
- Runway edge lighting (high-intensity runway light system): white lights changing to yellow lights on the last 2,000 feet of the runway.

Summary

Runway excursions and runway overruns can be categorized into six families of events, depending on their primary causal factor:

- Events resulting from unstabilized approaches;
- Events resulting from incorrect flare technique;
- Events resulting from unanticipated or more-severe-than-expected adverse weather conditions;
- Events resulting from reduced braking or loss of braking;
- Events resulting from an abnormal configuration (e.g., because the aircraft was dispatched under MEL conditions or dispatch deviation guide [DDG] conditions, or because of an in-flight malfunction); and,
- Events resulting from incorrect crew action and coordination, under adverse conditions.

Corresponding company accident-prevention strategies and personal lines of defense can be developed to help prevent runway excursions and runway overruns by:

- Adherence to SOPs;
- Enhanced awareness of environmental factors;
- Enhanced understanding of aircraft performance and handling techniques; and,
- Enhanced alertness for flight-parameter monitoring, deviation calls and crew cross-check.

The following FSF ALAR Briefing Notes provide information to supplement this discussion:

- 1.1 — *Operating Philosophy*;
- 1.4 — *Standard Calls*;
- 6.4 — *Bounce Recovery — Rejected Landing*;
- 7.1 — *Stabilized Approach*;
- 8.2 — *The Final Approach Speed*;
- 8.3 — *Landing Distances*;
- 8.4 — *Braking Devices*;
- 8.5 — *Wet or Contaminated Runways*; and,
- 8.7 — *Crosswind Landings*.♦

Reference

1. Flight Safety Foundation. "Killers in Aviation: FSF Task Force Presents Facts About Approach-and-landing and

Controlled-flight-into-terrain Accidents." *Flight Safety Digest* Volume 17 (November–December 1998) and Volume 18 (January–February 1999): 1–121. The facts presented by the FSF ALAR Task Force were based on analyses of 287 fatal approach-and-landing accidents (ALAs) that occurred in 1980 through 1996 involving turbine aircraft weighing more than 12,500 pounds/5,700 kilograms, detailed studies of 76 ALAs and serious incidents in 1984 through 1997 and audits of about 3,300 flights.

Related Reading from FSF Publications

Flight Safety Foundation (FSF) Editorial Staff. "Business Jet Overruns Wet Runway After Landing Past Touchdown Zone." *Accident Prevention* Volume 56 (December 1999).

FSF Editorial Staff. "Attempted Go-around with Deployed Thrust Reversers Leads to Learjet Accident." *Accident Prevention* Volume 56 (January 1999).

Enders, John H.; Dodd, Robert; Tarrel, Rick; Khatwa, Ratan; Roelen, Alfred L.C.; Karwal, Arun K. "Airport Safety: A study of Accidents and Available Approach-and-landing Aids." *Flight Safety Digest* Volume 15 (March 1996).

Lawton, Russell. "DC-10 Destroyed, No Fatalities, After Aircraft Veers Off Runway During Landing." *Accident Prevention* Volume 51 (May 1994).

King, Jack L. "During Adverse Conditions, Decelerating to Stop Demands More from Crew and Aircraft." *Flight Safety Digest* Volume 12 (March 1993).

Regulatory Resources

International Civil Aviation Organization (ICAO). *International Standards and Recommended Practices, Annex 6 to the Convention of International Civil Aviation, Operation of Aircraft, Part I, International Commercial Air Transport – Aeroplanes.*

Appendix 2, "Contents of an Operations Manual," 5.9. Seventh edition – July 1998, incorporating Amendments 1–25.

ICAO. *Procedures for Air Navigation Services. Aircraft Operations.* Volume 1, *Flight Procedures.* Fourth edition, 1993. Reprinted May 2000, incorporating Amendments 1–10.

ICAO. *Manual of All-Weather Operations.* Second edition – 1991.

ICAO. *Preparation of an Operations Manual.* Second edition – 1997.

U.S. Federal Aviation Administration (FAA). *Federal Aviation Regulations.* 121.97 "Airports: Required data," 121.117 "Airports: Required data," 121.133 "Preparation," 121.141 "Airplane Flight Manual," 121.401 "Training program: General," 121.195 "Airplanes: Turbine-engine-powered: Landing limitations: Destination airports," 121.197 "Airplanes: Turbine-engine-powered: Landing limitations: Alternate airports," 125.287 "Initial and recurrent pilot testing requirements," 135.293 "Initial and recurrent pilot testing requirements." January 1, 2000.

FAA. Advisory Circular 120-51C, *Crew Resource Management Training.* October 30, 1998.

FAA. *Air Transportation Operations Inspector's Handbook.* Volume 4, "Aircraft Equipment and Operational Authorizations." Chapter 2, "All-weather Terminal Area Operations," August 26, 1998, incorporating changes 1–12.

Joint Aviation Authorities. *Joint Aviation Requirements – Operations 1. Commercial Air Transportation (Aeroplanes).* 1.515 "Landing – Dry Runways," 1.520 "Landing – Wet and contaminated runways." March 3, 1998.

U.K. Civil Aviation Authority (CAA). Aeronautical Information Circular (AIC) 11/98, *Landing Performance of Large Transport Aeroplanes.* January 27, 1998.

U.K. CAA. AIC 61/1999, *Risks and Factors Associated with Operations on Runways Affected by Snow, Slush or Water.* June 3, 1999.

Notice

The Flight Safety Foundation (FSF) Approach-and-landing Accident Reduction (ALAR) Task Force has produced this briefing note to help prevent ALAs, including those involving controlled flight into terrain. The briefing note is based on the task force's data-driven conclusions and recommendations, as well as data from the U.S. Commercial Aviation Safety Team (CAST) Joint Safety Analysis Team (JSAT) and the European Joint Aviation Authorities Safety Strategy Initiative (JSSI).

The briefing note has been prepared primarily for operators and pilots of turbine-powered airplanes with underwing-mounted engines (but can be adapted for fuselage-mounted turbine engines, turboprop-powered aircraft and piston-powered aircraft) and with the following:

- Glass flight deck (i.e., an electronic flight instrument system with a primary flight display and a navigation display);
- Integrated autopilot, flight director and autothrottle systems;

- Flight management system;
- Automatic ground spoilers;
- Autobrakes;
- Thrust reversers;
- Manufacturers'/operators' standard operating procedures; and,
- Two-person flight crew.

This briefing note is one of 34 briefing notes that comprise a fundamental part of the FSF *ALAR Tool Kit*, which includes a variety of other safety products that have been developed to help prevent ALAs.

This information is not intended to supersede operators' or manufacturers' policies, practices or requirements, and is not intended to supersede government regulations.

Copyright © 2000 Flight Safety Foundation
Suite 300, 601 Madison Street, Alexandria, VA 22314 U.S.
Telephone +1 (703) 739-6700, Fax: +1 (703) 739-6708
www.flightsafety.org

In the interest of aviation safety, this publication may be reproduced, in whole or in part, in all media, but may not be offered for sale or used commercially without the express written permission of Flight Safety Foundation's director of publications. All uses must credit Flight Safety Foundation.

10.4

Appendix D - FAA/industry-agreed braking action definitions

The following table (Table D.1) of Federal Aviation Administration (FAA) and industry-agreed braking action definitions is reproduced from FAA Advisory Circular AC 91-79 *Runway Overrun Prevention*.

Table D.1: FAA/industry-agreed braking action definitions

Braking action		Estimated correlations		
Term	Definition	Runway surface condition	ICAO	
			Code	Mu
<i>Good</i>	Braking deceleration is normal for the wheel braking effort applied. Directional control is normal.	- water depth of 1/8" (3 mm) or less - dry snow less than 3/4" (20 mm) in depth - compacted snow with OAT at or below 15 °C	5	40 and above
<i>Good to medium</i>			4	39-36
<i>Medium (fair)</i>	Braking deceleration is noticeably reduced for the wheel braking effort applied. Directional control may be slightly reduced.	- dry snow 3/4" (20 mm) or greater in depth - sanded snow - sanded ice - compacted snow with OAT above 15 °C	3	35-30
<i>Medium to poor</i>			2	29-26
<i>Poor</i>	Braking deceleration is significantly reduced for the wheel braking effort applied. Potential for aquaplaning exists. Directional control may be significantly reduced.	- wet snow - slush - water depth more than 1/8" (3 mm) - ice (not melting)	1	25-21
<i>Nil</i>	Braking deceleration is minimal to nonexistent for the wheel braking effort applied. Directional control may be uncertain. NOTE: The FAA prohibits taxi, takeoff and landing operations in 'nil' conditions.	- ice (melting) - wet ice	9	20 and below

Source: FAA, 2007

10.5

Appendix E - FAA sample worksheet for calculating landing length

Table E.1 replicates a sample worksheet provided by the United States Federal Aviation Administration (FAA) for calculating landing length. It is sourced from FAA Advisory Circular AC 91-79 *Runway Overrun Prevention*. It is intended to be used by flight crew as a tool when calculating actual landing rollout length as part of a pre-landing risk and threat briefing. To provide a safe and conservative estimate of actual required rollout length, this worksheet applies factors of safety for various local conditions at the time of landing.

The sample landing rollout length estimate below is based on an aircraft intending to land at night on a wet, windy runway, with some unserviceable aircraft systems. The baseline unfactored dry landing length for the aircraft (as provided by the manufacturer in the Aircraft Flight Manual (AFM)) is 3,000 ft (914 m).

Table E.1: FAA sample worksheet for calculating landing length

1. Un-factored AFM landing distance (baseline data for a dry runway)	3,000 ft (914 m)
2. Airspeed additive to be held to the landing threshold (e.g. all of the gust). Max additive of 20kts. Landing distance increase: - Dry runway: 20-30 ft per knot - Wet runway: 40-50 ft per knot - Extended flare: 250 ft per knot	(5 kt additive) 250 ft (76 m) (wet rwy) 1,250 ft (381 m) (extended flare)
3. Add 2 seconds flare time due to gusty winds (results in a 230 ft/sec additive)	460 ft (140 m)
4. Night – no glide path: assume a 10 ft error (add 200 ft to the landing distance)	200 ft (61 m)
5. Any additions caused by minimum equipment list or dispatch deviation guide requirements	500 ft (152 m)
6. <i>Subtotal (1+2+3+4+5)</i>	<i>5,660 ft (1,725 m)</i>
7. Runway condition – if wet, add 15 per cent of line 6, or use AFM data if available	850 ft (259 m)
8. Contaminated runway adjustment to line 6, as per AFM and standard operating procedures	0 ft (0 m)
9. Less than maximum braking – add 20 per cent of line 6, or use AFM data if available	1,130 ft (344 m)
10. Total (6+7+8+9)	7,640 ft (2,329 m)

Source: FAA, 2007

10.6 Appendix F - Tailwind limits for common commercial aircraft

Table F.1 lists the tailwind limits for some common regular public transport (RPT) aircraft (both turbofan and turboprop). Most of these aircraft have been in commercial service with Australian operators, or are used by international operators servicing Australia.

Table F.1: Tailwind limits for common commercial RPT aircraft

Manufacturer	Model	Tailwind limit (kts) ²⁷
ATR	ATR-42	15
ATR	ATR-72	10
Airbus	A300-600	10
Airbus	A310-200/300	10
Airbus	A319/320/321	15
Airbus	A330	15
Airbus	A340	15
Boeing	737	10*
Boeing	747-300/400	15
Boeing	757-200/300	15
Boeing	767-200/300	15
Boeing	777-200	15
British Aerospace	RJ70/85/100	15
British Aerospace	BAe 146-200 (steep approach)	5
British Aerospace	BAe 146-200 (landing)	15
De Havilland Canada	DHC-8	10
Embraer	EMB-145	10
Fairchild	SA226 Metroliner	10
Fokker	F70/100	10
Fokker	F50	10
McDonnell Douglas	MD-80/90	10
McDonnell Douglas	MD-11	10
Saab	S340	10

Source: van Es & Karwal, 2001

²⁷ A tailwind of 15 kts is sometimes certified for some specific types (marked with an asterisk) following customer requests through a major change to the type certificate.

10.7

Appendix G - Landing force calculations

This Appendix provides the equations and assumptions used to calculate the approximate braking force available to stop a Boeing 787-8 Dreamliner, from the point of touchdown until the end of the landing rollout. Braking is based on aerodynamic and wheel braking only (no reverse thrust).

Two calculations are provided, each with differing runway friction coefficient (μ) values. The first assumes dry runway conditions. The second assumes a landing on a water-affected runway. Both calculations assume:

- landing in international standard atmosphere (ISA²⁸) sea level atmospheric conditions;
- manufacturer-quoted stall and approach speeds for the aircraft;
- landing at maximum allowable landing weight;
- no tailwind or crosswinds, no reverse thrust (i.e. $T_{REV} = 0$); and
- 35 degrees flaps.

Ground effects are not considered.

Equations and some constants have been developed from first principles, or adapted from Brandt, Stiles, Bertin & Whitford (1997). Data for the Boeing 787 is based on a late-2005 baseline. It is sourced from Jane's and the Piano database, which provides a performance model for this aircraft based on manufacturer data. Piano is a globally trusted aeronautical analysis tool used by over 20 major aerospace organisations.

It is important to note that the calculations provided do not reflect the actual in-service performance of the Boeing 787, as this evaluation was based off a pre-production performance baseline and is not approved by Boeing. This baseline is unlikely to be the same as the actual performance of the Boeing 787 when it enters into service.

Constants

Table G.1: Boeing 787-8 parameters (late-2005 baseline)

Aircraft weight and performance		
Stall speed	V_s	102 kts
Maximum landing weight	W_L	365,000 lb (165,561 kg)
Dimensions and areas		
Wing area	S	325.25 m ² (3,501 ft ²)
Aerodynamic data		

²⁸ The ISA is an internationally accepted model of the Earth's atmosphere, and defines how air pressure, temperature, density and viscosity change over a range of altitudes. At sea level, the ISA base temperature is 15°C at a pressure of 101.325 kPa. The International Organization for Standardization (ISO) publishes the ISA as international standard ISO 2533:1975.

Atmospheric density (ISA sea level)	ρ	1.224 kg/m ³ (0.076 lb/ft ³)
Maximum landing lift coefficient (flaps deployed)	C_{Lmax}	2.6
Approach lift-drag ratio (gear down)	L/D_{app}	6.96
Landing roll average lift coefficient (<i>Figure G.2</i>)	C_L	0.8
Runway friction coefficients		
Dry runway	μ	0.5
Water-affected runway	μ	0.2

Source: Jane's, 2008; FAA, 2007; Lissys Piano, 2006

Figure G.1: Boeing 787-8 free body diagram (landing rollout)

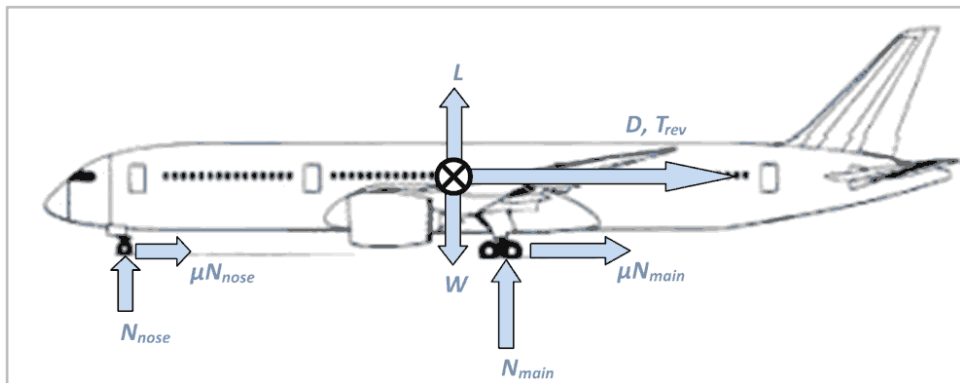

Source: Adapted from Jane's, 2008

Figure G.2: Boeing 787-8 lift-drag curve (approach, flaps deployed, gear up)

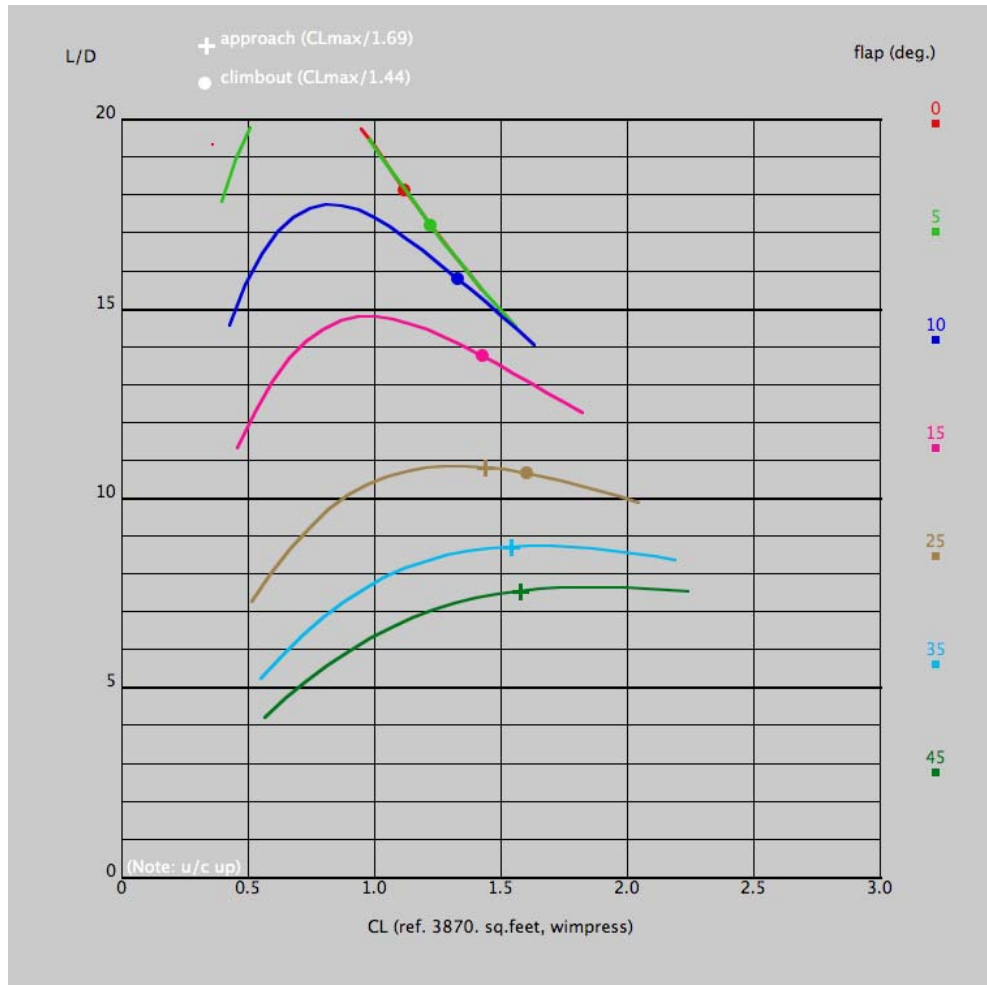

Source: Lissys Piano, 2006

Calculations

The free body diagram in Figure G.1 shows the major forces acting on an aircraft during the landing roll.

$$V_S = 102kts = 52.47m/s$$

$$W = 365,000lb = 165,561kg = 1,624.15kN$$

$$V_L = 1.3V_S = 1.3(52.47) = 68.21m/s$$

Average deceleration forces during the landing roll are calculated at 70 per cent of V_L (47.75 m/s).

$$L = \frac{1}{2} \rho V_L^2 S C_L$$

$$\Rightarrow \frac{1}{2} (1.224) (47.75)^2 (325.5) (0.8) = 363.32 \text{ kN}$$

$$D = L \div \frac{L}{D_{app}}$$

$$\Rightarrow \frac{363.32}{6.96} = 52.20 \text{ kN}$$

$$N = W - L$$

$$\Rightarrow 1624.15 - 363.32 = 1260.83 \text{ kN}$$

The equation for landing rollout length is provided below (Brandt et al, 1997). Assume no reverse thrust is being used ($T_{REV} = 0$). The weight of the aircraft on landing has an effect on the rollout length – heavier aircraft require longer rollouts.

$$s_L = \frac{1.69 W_L^2}{\rho S C_{L_{max}} [D + \mu N + T_{rev}]_{0.7V_L}}$$

$$s_L = \frac{0 - V_L^2}{2a}$$

$$\Rightarrow a = -\frac{1}{2} \left(\frac{V_L^2}{s_L} \right)$$

$$F = ma$$

For a Mu value of 0.5 (dry runway conditions), the estimated landing rollout length is:

$$s_{L(dry)} = \frac{4.46 \times 10^{12}}{(1.224)(325.25)(2.66)(9.81)[52200 + (0.5)(1260830) + 0]}$$

$$\Rightarrow \frac{4.46 \times 10^{12}}{7.09 \times 10^9} = 629 \text{ m} = 2,063 \text{ ft}$$

Comparing against the (estimated) Boeing 787-8 certified dry runway baseline landing rollout length of 2,037 ft (621 m) (Lissys Piano, 2006), this value is a good match.

If the runway was affected by standing water (Mu value reduced to 0.2), the required rollout length would be (assuming the same approach speeds, weights etc.):

$$s_{L(dry)} = \frac{4.46 \times 10^{12}}{(1.224)(325.25)(2.66)(9.81)[52200 + (0.2)(1260830) + 0]}$$

$$\Rightarrow \frac{4.46 \times 10^{12}}{3.16 \times 10^9} = 1,411 \text{ m} = 4,629 \text{ ft}$$

The reduction in friction caused by the wet runway **increase the landing rollout length by 225 per cent.**

This reinforces the need to have standard operating procedures (SOPs) in place that govern water-affected and contaminated operations. Prudent deployment of braking devices and the use of full reverse thrust are important components of SOPs for landing on water-affected runways.

The landing rollout length can be converted to a deceleration force using Newton's equations of motion:

$$s_L = \frac{0 - V_L^2}{2a}$$

$$\Rightarrow a = -\frac{1}{2} \left(\frac{V_L^2}{s_L} \right)$$

$$F = ma$$

For a Mu value of **0.5** (dry runway conditions), the estimated braking force available to decelerate the aircraft at the point of touchdown (using 100 per cent V_L) is:

$$a = -(0.5) \left(\frac{68.21^2}{629} \right) = -3.70 m/s^2$$

$$F = (165561) |-3.70| = 612.58 kN$$

For a Mu value of **0.2** (water-affected runway conditions), the estimated braking force available to decelerate the aircraft at the point of touchdown (using 100 per cent V_L) is:

$$a = -(0.2) \left(\frac{68.21^2}{1411} \right) = -0.66 m/s^2$$

$$F = (165561) |-0.66| = 109.18 kN$$

In wet conditions, **only 18 per cent of the dry runway braking force is available** to stop the aircraft.

Maximum reverse thrust (if used) would provide a significant amount of additional braking force. For the 787-8, power is expected to be provided from a choice of two General Electric GENx or two Rolls-Royce Trent 1000 high-bypass turbofans in the 64,000 lb (284.7 kN) class.

Full reverse thrust would add as much as 569 kN to decelerate the aircraft. On a dry runway, this is almost another 100 per cent of the braking force available from all other sources.

Runway excursions
Part 1: A worldwide review of commercial jet aircraft runway excursions